



GHARLENI

SPA, BEAUTY & WELLNESS

Moers, Germany | Sales + Showroom // Gharieni Group GmbH • Gutenbergstr. 40 • D-47443 Moers

Moers, Germany | Distribution + Service // Gharieni Group GmbH • Am Schürmannshütt 24 • D-47441 Moers

Tel: +49 - (0) 28 41 - 88 300 - 0 • Fax: +49 - (0) 28 41 - 88 300 - 333 • www.gharieni.com • info@gharieni.com

Ettlingen | Germany // Gharieni Süd GmbH • Siemensstr. 11 • D-76275 Ettlingen

Tel: +49-(0)7243-3322-363 • Fax: +49-(0)7243-3322-391 • ettlingen@gharieni.com

Nederweert | BeNeLux // Gharieni Nederland BV • Hulsenweg 14 • NL-6031SP Nederweert

Tel: +31 (0) 495 - 63 30 36 • Fax: +31 (0) 495 - 62 66 63 • www.gharieni.nl • info@gharieni.nl

Belfort | France // Gharieni France SARL • 5 Rue Jacqueline Auriol • F-90000 Belfort

Tel: +33 (0) 3 39 03 39 47 • Fax.: +33 (0) 3 39 03 39 48 • www.gharieni.fr • info@gharieni.fr

Dubai | UAE // Gharieni Middle East FZ-LLC • Dubai Design District D3 • Building 1 Office B208 • Dubai

Tel: +971 (0) 4 276 6734 • www.gharieni.ae • info@gharieni.ae

Aventura | USA // Gharieni USA Inc. • JW Marriott Miami Turnberry Resort & Spa • 19999 West Country Club Drive • Aventura Florida 33180

Tel: +1 (855) 378 4772 • www.gharieni.com • info@gharieni.com



GREEN SPA is a sustainability initiative of the German Wellness Association for the spa and wellness industry. Our company supports the sustainable operation of spa and wellness facilities with suitable products and/or services.



Contents

Table Options	20	Loungers	156	Treatment Units	254
Wellness Concepts	26	Evo Lounger	158	Spa Trolley HST series	256
Psammo Concept	30	RL Aqua	164	Spa Trolley GST	258
Wellmassage4D	40	RLX series	168	AluVap	262
Spa.Wave	46			Twin	266
MLX Dôme	52			Shiro Dhara series	268
HydroSpa	56	Massage Tables	174	GlaStyle	270
PediSpa Square	58	MLW Transform	176	AluVap Junior	272
PediSpa Compact	64	Ellipse	180		
PediSpa Curve	68	RLL series	182	Furnishings	276
Hair Swing	74	ML series	186	K8 Furniture series	278
Libra Edge	76	Ayurveda Table	192	K9 Furniture series	282
MLR Wet	82	Shiatsu Mat	198	K10 Furniture series	284
V-Box	86	Massage Tables accessories	200	MLX Trolley series	292
Jet Shower	88			MO Trolley	298
		Treatment Beds	202	Square Trolley	300
Spa Tables	90	Lina Select series	204	EasyStore series	302
MLX Limber series	92	SPL Sphinx	212	Laundry Trolley TK	304
MLX	98	SPL series	218	CL Trolley	306
MLR Classic	104	SPX series	224	GL Trolley series	308
MLR Select series	110	SLXP series	230	Cube Trolley series	310
MO1 Evo series	118	Hydraulic series	236	Vario Trolley series	314
MO1 Square series	120	SLR	240	GlaStyle Trolley	316
MLW F1 series	126	LR	246	Pedicart	318
MLW F2	132	Treatment Beds accessories	252	Lamica Trolley series	320
MLW series	138			Manicure Table Mano	324
MLW Square	148			Manicure Table Cube Square	326
Spa Tables accessories	154			Manicure Table Cube Select	328
				Stools & Chairs	332

Our awards

Various awards from the wellness, cosmetic, and medical industries for individual products, innovative developments, the highest quality, top design, as well as for excellent service and guarantee standards confirm our concept.

Brand Official 2019 Forbes Travel Guide

Beauty Forum Sonderpreis der Redaktion – International Top Brand Spa Award 2018

ESPA Innovation Awards 2018 Special Jury Price (Spa.Wave System)

Spa & Wellness MexiCaribe Product Award 2017 (Spa.Wave System)

American Spa Magazine Professionals Choice Award 2017 (HydroSpa)

Beauty Forum Sonderpreis der Redaktion – Spa International Award 2016/17

Spa & Wellness Mexico Product Awards 2016 (WellMassage4D)

ESPA – Winner „Innovative Spa Concept“ 2016 (WellMassage4D)

Wellness & Spa Innovation Award 2016 (WellMassage4D)

Dermascope Aesthetician Choice Awards 2016 (PediSpa Square)

Spa Professional Mexico Product Award for Best Spa Furniture 2015 (MLX Quartz)

Beauty Forum Sonderpreis der Redaktion – Spa International 2014

Beauty Forum Readers' Choice Award 2013/2014

Beauty Forum Award 2012/2013

Beauty Forum Readers' Choice Award 2011/2012

Beauty Forum Award 2010/2011

Beauty Forum Readers' Choice Award 2009/2010

Medical Design Excellence Award (USA) 2009

Perfect Line (Poland) 2009

Beauty Forum Readers' Choice Award 2007/2008

Beauty Forum Award 2006





Gharieni Group is Brand Official 2019 of Forbes Travel Guide

About Forbes Travel Guide

Forbes Travel Guide is the only independent, global rating system for luxury hotels, restaurants and spas. Started as Mobil Travel Guide in 1958, the company created the first Five-Star rating system in the United States. Today, Forbes Travel Guide's incognito inspectors travel the world, evaluating properties based on up

to 900 rigorous, objective standards. The company's annual Star Ratings, reviews and daily travel stories help discerning travelers select the world's best luxury experiences.

Read more about Forbes Travel Guide: www.forbestravelguide.com

The Gharieni Group has been selected as a Forbes Travel Guide Brand Official

Moers, Germany: The Gharieni Group was chosen as the Official Spa & Wellness Equipment Manufacturer for Forbes Travel Guide, the global authority on luxury travel. Selected to represent the best products and services in the luxury hospitality industry, Gharieni embodies the core values and exacting quality standards demanded by FTG, the only independent, global rating system for luxury hotels, restaurants and spas.

Sammy Gharieni, CEO and Founder of the Gharieni Group states, "This great recognition by Forbes Travel Guide serves to reinforce our commitment to delivering stellar service, supreme comfort and impeccable design to our partners in the hotel and resort category. From the initial design concept to the installation of its equipment, Gharieni strives to deliver a memorable and impactful treatment experience to the guest and provider by incorporating multi sensorial components and full customization capabilities. This acknowledgement by Forbes Travel Guide will only reinforce our purpose in providing the utmost attention to design detail and differentiation in our equipment and furnishings."

"We are pleased to name the Gharieni Group as the Official Spa & Wellness Equipment Manufacturer of Forbes Travel Guide," said Filip Boyen, CEO of Forbes Travel Guide. "Gharieni's team of experts oversees every step of design and customizes spa tables, treatment beds and more based on client need. The company, which has more than 25 years in the business, puts guest experience at the forefront of its innovative products."

The Gharieni Group

With more than 25 years of experience, Gharieni Group GmbH is one of the leading international manufacturers of high-quality spa tables, treatment tables, and equipment for the areas of spa, wellness, cosmetics, and foot care/podiatry.

Our tables and device furnishings, as well as our cosmetic and medical equipment, are sold on all continents in nearly 100 countries worldwide. Luxury hotels as well as high-end spas and resorts around the globe rely on our "Made in Germany" products.

First-class material, outstanding quality, the best functionality, modern design, and exclusive innovations, coupled with the flexibility to respond quickly to customer requirements: that is our company's maxim.

We do not just think of ourselves as a manufacturer of equipment. We are in fact concerned with creating very special wellness experiences. Thus we have both the end

customer as well therapists in mind. We want to offer end customers unique relaxation and treatment experiences and therapists absolutely comfortable, ergonomic working with our products.

When developing our products, we think it's important to "think outside the box." Our in-house development department works continuously with specialists from other professions. This brainpool isn't just the birthplace of new ideas. The expertise and innovations of other industry branches are also profitably incorporated here, such as in the fields of medicine and technology. In addition, designers with their expert knowledge are available for visually and functionally convincing implementation.

Our vision is simple: We want to offer you as our customer nothing less than the best possible equipment for unforgettable moments.



Certified Quality

for Gharieni treatment tables
and treatment units

"Made in Germany" production



In order to always live up to the "Made by Gharieni" brand, the standard "quality without compromise" applies in our company. This also includes guaranteed quality, because only this offers customers both transparency and security. In order to provide you with clear facts about the proof of production and to show that social responsibility as well as consumer interests are very important to us, we have put ourselves through a costly certification procedure by TÜV NORD and since early 2012 it's "official." In accordance with the TÜV NORD test criteria, our products in the areas of treatment tables and treatment units may be awarded the seal "Made in Germany!"

Quality management
in accordance with ISO 13485



Of course, our manufacturing and administration are also subject to constant quality control. Comprehensive quality management of business processes has been in existence for over ten years and includes ISO 13485 certifications. As a customer, this guarantees you both product quality and excellent service, a combination that can hardly be found elsewhere!



AIDA-Cruises, Hyperion-Klasse // TUI Cruises, Mein Schiff 2 - 5 // MS Europa 2 // P&O Pacific Dawn // Severin's Resort & Spa***** Sylt, Germany // Grand Hotel & SPA Kurhaus Ahrenshoop***** Ahrenshoop, Germany // Titanic Hotel Berlin***** Berlin, Germany // "Kreuz-Post" Hotel-Restaurant-Spa*** Vogtsburg, Germany // A-ROSA Scharmützelsee***** Bad Saarow, Germany // Hotel Bülow Palais***** Dresden, Germany // Hotel Hyatt Regency***** Düsseldorf/Mainz/Cologne, Germany // Grand Hyatt Berlin***** Germany // Hotel Traube Tonbach***** Baiersbronn, Germany // Jumeirah Frankfurt***** Germany // Parkhotel Bansin***** Usedom, Germany // Steigenberger Hotel Frankfurter Hof***** Germany // Grand Hotel Heiligendamm***** Bad Doberan-Heiligendamm, Germany // The Westin Grand München***** Munich, Germany // A-Ja Resort***** Warnemünde, Germany // Althoff Seehotel Überfahrt***** Rottach-Egern, Germany // Lindner Hotel Dom Residence**** Cologne, Germany // Brenners Park-Hotel & Spa***** Baden-Baden, Germany // Nordseefarm**** Büsumer Deichhausen, Germany // Relais & Châteaux Hotel Die Sonne Frankenberg*****s Germany // Hotel Bergström**** Lüneburg, Germany // Wellnesshotel Bodenmaier Hof***** Bodenmais, Germany // Steigenberger Hotel am Kanzleramt***** Berlin, Germany // Titanic Deluxe Berlin***** Germany // Titanic Chaussee Berlin**** Germany // Hotel BEI SCHUMANN*****s Schirgiswalde, Germany // Budersand Hotel, Golf & Spa***** Sylt, Germany // Cliff Hotel Rügen - Resort & Spa***** Germany // Colombi Hotel***** Freiburg, Germany // Das Stue***** Berlin, Germany // Althoff Grandhotel Schloss Bensberg***** Bergisch-Gladbach, Germany // Kameha Grand Bonn***** Germany // Hotel Romantischer Winkel***** Bad Sachsa, Germany // Steigenberger Grandhotel & Spa Usedom, Germany // Swissôtel Dresden Am Schloss***** Germany // The Mandala Hotel***** Berlin, Germany // Das König Ludwig Wellness & SPA Resort Allgäu*****s Schwangau, Germany // Moselromantik-Hotel Keßler-Meyer ****s Cochem, Germany // Kempinski Hotel Frankfurt Gravenbruch***** Neu-Isenburg, Germany // Lindner Parkhotel & Spa**** Oberstaufen, Germany // InterContinental Düsseldorf***** Germany // Ulrichshof Baby & Kinder Bio-Resort**** Rimbach, Germany // Wellings Romantik Hotel zur Linde**** Moers, Germany // Steigenberger Grandhotel and Spa Heringsdorf, Germany
 W Amsterdam***** Netherlands // Corendon City Hotel Amsterdam**** Netherlands // The Lamp Hotel**** Norrköping, Sweden // Hotel Kaiserblick Ellmau**** Austria // Hotel Sans Souci***** Vienna, Austria // Grand Tirolia***** Kitzbühel, Austria // Park Hyatt Vienna***** Austria // AIGO welcome family*****s Aigen, Austria // Hilton Vienna Plaza***** Austria // Grand Hotel, Wien***** Austria // Genusssdorf Gmachl*****s Bergheim, Austria // Wanderhotel Gassner***** Neukirchen am Großvenediger, Austria // Bürgenstock Resort Lake Lucerne***** Switzerland // The Dolder Grand***** Zurich, Switzerland // InterContinental Davos***** Switzerland // W Verbier***** Switzerland // Seehotel Waldstätterhof***** Brunnen, Switzerland // The Alpina Gstaad***** Switzerland // Hotel Crans Ambassador Luxury Sport Resort***** Crans-Montana, Switzerland // Hotel Plunhof**** South-Tirol, Italy // Falkensteiner Resort Capo Boi***** Villasimius, Italy // GOCO Spa Venice at JW Marriott***** Italy // Preidlhof Luxury DolceVita Resort***** Naturno, Italy // Mandarin Oriental Milan***** Italy // Maison Albar Hotel Paris Champs-Élysées***** France // Le M de Megève***** France // InterContinental Marseille Hôtel Dieu***** France // Hotel Molitor Paris - Mgallery Collection***** France // Le Pavillon de la Rotonde***** Charbonnières les Bains, France // Hotel Sofitel Biarritz le Miramar Thalassa Sea & Spa***** France // Hôtel La Réserve Paris***** France // Grand Hôtel de Cala Rossa & Spa by Clarins R&C***** Corsica, France // Hotel Barriere Les Neiges***** Courchevel, France // The Ritz-Carlton, Budapest ***** Hungary // The Beaumont***** London, England // Seaham Hall Hotel & Spa***** Durham, England // The May Fair***** London, England // Mandarin Oriental Hyde Park, London***** England // Radisson Blu Edwardian***** Manchester, England // Jumeirah Carlton Tower***** London, England // Ramside Hall Hotel & Spa**** Durham, England // Grand Jersey Hotel & Spa***** St Helier, Jersey // Four Seasons Hotel Hampshire***** England // Galgorm Resort & Spa**** Ballymena, Northern Ireland // Talacre Beach Holiday Home Park Wales // Gazelli House London, England // The Manor House***** Wiltshire, England // Four Seasons Hotel London at Ten Trinity Square***** England // Puente Romano***** Marbella, Spain // The One Barcelona***** Spain // Sheraton Mallorca Arabella Golf Hotel***** Palma de Mallorca, Spain // Park Hyatt Mallorca***** Spain // The Ritz-Carlton***** Istanbul, Turkey // Mandarin Oriental, Bodrum***** Turkey // Gloria Serenity Resort***** Belek, Turkey // Maxx Royal Kemer Resort***** Kemer, Turkey // Regnum Carya Golf & Spa Resort***** Belek, Turkey // JW Marriott Hotel Ankara***** Turkey // Raffles Istanbul***** Turkey // Vidago Palace Hotel***** Portugal // Hotel Metropol***** Monte Carlo, Monaco // Kempinski Hotel Grand Arena Bansko***** Bulgaria // Hotel Arłamów**** Poland // Hilton Tallinn Park ***** Estonia // Four Seasons Hotel Moscow***** Russia // IDW Esperanza Resort***** Lithuania // Nikki Beach Hotel Porto Heli ***** Porto Cheli, Greece // Intercontinental Doha***** Qatar // The Ritz-Carlton Doha***** Qatar // Sofitel Dubai The Palm Resort & Spa***** UAE // Caesars Palace Bluewaters***** Dubai, UAE // The Oberoi***** Dubai, UAE // Six Senses Hideaway Ziggy Bay***** Oman // Viceroy Dubai***** UAE // Palazzo Versace Dubai ***** UAE // Four Seasons Hotel Abu Dhabi At Al Maryah Island***** UAE // The Address Downtown Dubai***** UAE // Talise Spa Madinat Jumeirah Dubai, UAE // Burj Al Arab***** Dubai, UAE // Emirates Palace Abu Dhabi ***** UAE // The Peninsula***** Hong Kong // Rosewood Beijing***** Peking, China

// Four Seasons Resort Langkawi***** Malaysia // The Chateau Spa & Organic Wellness Resort***** Kuala Lumpur, Malaysia // Cheval Blanc Randheli***** Noonu-Atoll, Maldives // Vela Private Island Maldives // The Oberoi Sukhvilas Resort & Spa***** Punjab, India // Anahita The Resort***** Mauritius // Four Seasons Hotel The Westcliff***** Johannesburg, South Africa // Hotel Sofitel Agadir Royal Bay Resort***** Morocco // Sofitel Marrakech***** Morocco // Mövenpick Hotel Gammarth***** Tunis, Tunisia // La Cigale Tabarka Hôtel-Thalasso & Spa - Golf***** Tunisia // Crown Towers Perth***** Australia // Sofitel Abidjan Hôtel Ivoire***** Côte d'Ivoire // Jumby Bay, A Rosewood Resort***** Antigua // Hilton Barbados ***** // Gran Caribe Kuba // Cheval Blanc St-Barth Saint-Barthélemy // The Brando Tetiaroa***** French Polynesia // Four Seasons Resort Seychelles at Desroches Island***** // JW Marriott Miami Turnberry Resort & Spa***** Miami, USA // Four Seasons Hotel Los Angeles at Beverly Hills***** California, USA // Carlsbad Oceanfront Resort & Spa***** California, USA // Grand Hyatt New York***** USA // SeaHill Spa at The Cavalier Hotel, Autograph Collection Hotel***** Virginia Beach, USA // Four Seasons Surf Club Miami ***** USA // Conrad Bora Bora Nui***** French Polynesia // Cosmopolitan Hotel East Tower ***** Las Vegas, USA // Peninsula Chicago ***** USA // Sothys Spa at Lucky Dragon Hotel & Casino***** Las Vegas, USA // Kona Kai Resort*** San Diego, USA // The Setai Hotel ***** Miami, USA // La Cantera Hill Country Resort*** San Antonio, USA // The Breakers***** Palm Beach, USA // Four Seasons Hotel Houston***** Texas, USA // Glen Ivy Hot Springs***** Corona, USA

7 Welten Therme & Spa Fulda/Künzell, Germany // Rupertus Therme Bad Reichenhall, Germany // Caracalla Therme Baden-Baden, Germany // Bali Therme Bad Oeynhausen, Germany // Aiyasha Medical Spa Munich, Germany // Dermedis Germany // Babor Beauty Spa's Germany // Flughafen Düsseldorf Germany // Lufthansa Lounge Frankfurt Airport Germany // Nordseefarm Büsumer Deichhausen, Germany // Purezense Spa Baden-Baden, Germany // H2 Beauty Lounges Bad Nauheim, Germany // KaDeWe Berlin, Germany // H1-Spa Konstanz, Germany // Pauline Bolmerg Kosmetik Berlin, Germany // Lasmiranda Tattoo & Beauty Herrenberg, Germany // estetica Medical Beauty and Wellness Iserlohn, Germany // HAUT+ Kosmetikinstitut Frankfurt, Germany // BABOR Beauty Spa Wien Vienna, Austria // Dhevari Spa Wien Vienna, Austria // Cosmeda International Rinteln, Germany // Cosmetic Institute Munich Airport, Terminal 2 Germany // Phytomer Spa & Wellness à St Malo France // Deep Nature Spa & Thalasso Algotherme Deauville France // Clarins Skin Spa Neuilly sur Seine France // Les thermes d'Evian Evian les Bains, France // Printemps Lyon, France // THIRTY NINE Monte Carlo Monaco // Limelight Spa (Rolex) Biel, Switzerland // The House of Elemis London, England // Lanes of London England // Zabeel Ladies Club Dubai, UAE // King Waterpark Dallas, USA // Island Spa Catalina Catalina Island, USA // Dr. Sears Center for Health and Wellness Palm Beach, USA // Bonita Bay Bonita Springs, USA // Ocean Reef Club Key Largo, USA

Praxisklinik MKG-Chirurgie Pescheck/Romsdorfer Schwäbisch Hall, Germany // Die Ästheteten - Mecial Spa Munich, Germany // BLUSH Beauty & Skin Clinic Amsterdam, The Netherlands // Doctors inc, Amsterdam, The Netherlands // Iuventu Anti-Aging Clinic Brussels, Belgium // Mohs Klinieken Amsterdam, The Netherlands // Guerlain L'Institut Praha Prague, Czech Republic // Institut de Formation et de Perfectionnement aux Métiers Nanterre, France // Dr. Dennis Gross NYC, USA

Rizzato Spa Consulting Tettngang, Germany // Cosmeda Rinteln, Germany // Jean d'Arcel Cosmétique KehL, Germany // Schulungszentrum Academie Scientifique de Beauté Baden-Baden, Germany // Dermalogica Schulungszentren Germany // Dr. Babor Schulungszentrum Aachen, Germany // Klapp Cosmetics Schulungszentren Germany // Malu Wilz Schulungszentrum Munich, Germany // Reviderm Munich, Germany // PUREBEAU Schulungszentrum Berlin, Germany // KTA Stabroek, Belgium // QMS Elen, Belgium // Domaine La Butte aux Bois Lanaken, Belgium // Chamomilla Vollenhove, The Netherlands // Absolution Creative Apothecary Appeldoorn, The Netherlands // Skins Cosmetics Groningen, The Netherlands // Dermalogica Breda, The Netherlands // Thalazur Arcachon, France // ENVIRON Benelux, France

Ligne St. Barth Munich, Germany // Hildegard Braukmann Kosmetik Germany // Icomfort zone Deventer, The Netherlands // Clarins USA Miami, USA // La Colline, Switzerland // NIANCE World of Luxury, Switzerland // Goldbad, Switzerland // Vinoble Fresing, Austria // Natura Bissé England // and many more!

are you
the next?

Testimonials

” *The Gharieni tables in our newly designed training center in Kehl are an absolute highlight, thanks not only their appearance, but also to their features. Exclusive design, unbelievable lying comfort, and varied technical equipment with easy handling make for an optimal package. All guests who attend our training academy are thrilled about the equipment.*

Horst Müller, Sales Marketing Director, JEAN D'ARCEL Cosmétique GmbH & Co.KG



” *We value the Gharieni brand not only because of its excellent products, which combine high quality with the best possible comfort and innovative design, but also because of the reliability of the after-sales service and the professional all-round customer service.*

Thomas Liebich, CEO, Gertraud Gruber Kosmetik GmbH & Co. KG



” *The Gharieni Quartz Table has been a fantastic addition to our treatment offering here at Glen Ivy. It has allowed us to offer a multidimensional service which not only wows and delights our guests but also keeps our therapists stimulated and engaged.*

Clive McNish, General Manager, Glen Ivy Hot Springs





Upon meeting Gharieni I was blown away not only by their Quartz treatment table, but by their passion and professionalism which is evident when meeting the team. From our initial meeting, right through until the installation of the Quartz table, the team have always been on hand to support and guide us particularly in the creation of our bespoke Quartz treatments. Gharieni are a joy to work with and I am excited for what is to come in the future.

Tara Moore, Spa Manager at Galgorm Resort & Spa

”



The vision for Crown Spa Perth was to create a luxury spa facility to rival the best in the world. Impeccably elegant, its philosophy is built squarely on the pillars of luxury, indulgence and on offering an unrivalled spa experience. To complement the stylish interiors, we partnered with Gharieni, world leaders in luxury treatment tables.

Emma McGrady Director of Crown Spa Melbourne and Perth

”



I chose the Gharieni brand when choosing the workspace furnishings, because I am particularly impressed by the professional and personal support of the team and the quality of the materials. The wide variety of setting functions, the comfort, as well as the heat adjustment of the tables are particularly worth noting. The practitioners love the reliability and the comfort of the Gharieni products.

Marlis Minkenberg, Beratung & Training

MARLIS MINKENBERG
BERATUNG & TRAINING

”

Our partners



www.elemis.com



www.guerlain.com

CLARINS

www.clarins.de



www.babor.com



www.biologique-recherche.com



www.lignestbarth.com

PHYTOMER

www.phytomer.com

MALU WILZ
BEAUTY COLLECTION

www.maluwilz.de

THĒMAË
PARIS

www.themae.fr

SHISEIDO

www.shiseido.com



www.academiebeaute.com

REVIDERM

www.reviderm.de

SOTHYS
PARIS

www.sothys.de

Ergoline

www.ergoline.com



www.rimpler.de



www.vinoble-cosmetics.at

THALGO
LA BEAUTE MARINE

www.thalgo.de

Pietrulla

www.pietrulla.de

PHARMOS NATUR
GREEN LUXURY

www.pharmos-natur.de

GOCO
HOSPITALITY

www.gocohospitality.com



www.ist.de

MONTEIL
PARIS

www.monteil.com

ANNEMARIE
BÖRLIND
NATURAL BEAUTY

www.boerlind.com

VOYA

www.voya.ie

HILDEGARD
BRAUKMANN

www.hildegard-braukmann.de

[**comfort zone**]
a complete sense of beauty

www.comfortzone.de



www.schupp.eu

La Colline
Swiss Riviera Beauty Treatment

www.colline.fr

GAZELLI
HOUSE

www.gazelliskincare.com

JEAN D'ARCEL
COSMETIQUE

www.jda.de

Cinderella
PARIS

www.cinderella.com

TIP TOUCH
INTERNATIONAL
AUDIT CONSULTING TRAINING

www.tiptouch.com



Dr. Spiller

Pure SkinCare Solutions

www.dr-spiller.com

Goldeneye
THE SKINCARE LABORATORY

www.goldeneye.de

NIANCE[®]
SWITZERLAND

www.niance.ch

SIX SENSES[®]
RESORTS & SPAS

www.sixsenses.com

DORN
BRACHT

www.dornbracht.com

VITALIS
DR JOSEPH



www.vitalisdrjoseph.com

URB'N
NATURE
ORGANIC COSMETICS

www.urbn-nature.com

KLAFS
MY SAUNA AND SPA

www.klafs.de

PUREBEAU

www.purebeau.com

GERTRAUD
GRUBER

KOSMETIK KULTUR

www.gertraud-gruber.de

La mer

Der Ursprung der Schönheit

www.la-mer.com

absolution
Creative Apothecary

www.absolution.nl

SUSANNE KAUFMANN™

www.susannekaufmann.com

FOX

KOSMETIK VERTEILERGESELLSCHAFT MBH

www.fox-kosmetik.de

RKF[®]
LUXURY LINES

www.rkf.fr

MARIA GALLAND
PARIS

www.maria-galland.de

AROMATHERAPY
ASSOCIATES
LONDON

www.aromatherapyassociates.com

CINQ MŌNDES
SPA PARIS

www.cinqmondes.com

cNc
SKINCARE

www.cnc-cosmetic.de

JANSSEN
COSMETICS

www.janssen-cosmetics.com

Doctor
Eckstein[®]
BioKosmetik

www.eckstein-kosmetik.de

KERSTIN
FLORIAN

www.kerstinflorian.com

ANNE SEMONIN
PARIS

www.annesemonin.com

dermalogica[®]

www.dermalogica.de

hannah[®]

www.hannahcosmetics.com

SKINCEUTICALS

www.skinceuticals.com

AURA | CHAKÉ INST.
PARIS

www.aurachake.fr

bamford

www.bamford.co.uk

BURGENER
SWITZERLAND

www.drburgener.com

DEYNIQUE

www.deynique.org

SPA CONNECTORS

www.spaconnectors.com

... and
many more

Glen Ivy Hot Springs Corona, USA





Photos: © Glen Ivy Hot Springs

Table Options

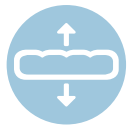

Soft Upholstery

In addition to the standard upholstery, tables with this symbol can also be equipped with a significantly thicker, very soft cushioning. Depending on the type of table, this soft upholstery is available with both a PU and synthetic leather cover. The extra-soft upholstery provides an even higher degree of lying comfort, in particular for longer treatment sessions.



Electrical Armrests

For even more comfort, the armrests - as well as the height, the back, leg, and foot section - can be fitted with actuators for electrical adjustment. In addition to direct control via pushbuttons on the armrests themselves, their position can be conveniently saved using the memory functions. This can bring the entire table into the preprogrammed position with the push of a button.



Electrical Triple-Airback®

Many of our spa tables and a few of our cosmetics models can be equipped with an electrically-controlled Triple-Airback®. This lordosis support system is divided into three individually controllable zones and perfectly adapts the cushion in the lower back area to the physical needs of your customers. Airback® is particularly appreciated during longer treatment sessions or by people with back problems.

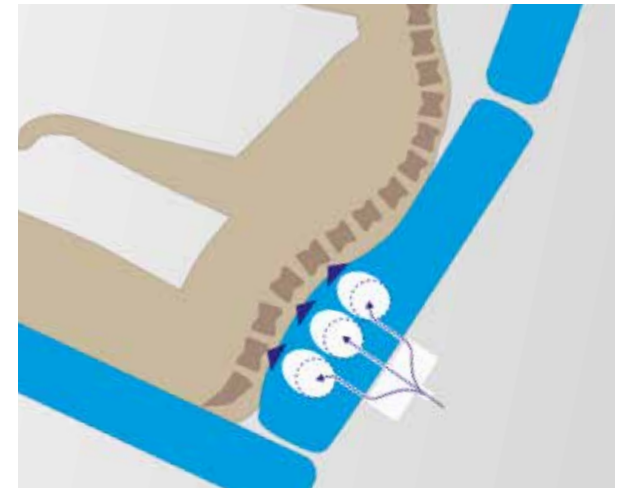

Smart-Thermo Heating System

The intelligent Smart-Thermo heating system is integrated into the upholstery of the table and works with modern microprocessor technology. During the start-up phase, it heats with full power to achieve a comfortable temperature on the surface as soon as possible. Then, it is kept constant until the safety switch automatically turns off the heating after a predefined time. The variable parameters can be set via a programming sequence, which is initiated by a specific key combination. The Smart-Thermo heating system works with DC and is therefore almost free from electrosmog.



Vibro-Wellness

Vibro-Wellness is a pleasantly massaging vibration system. Six or 10 different vibration motors in the upholstery can be controlled individually via a manual switch. The vibrations work on shoulder (back part), seat, and calves.

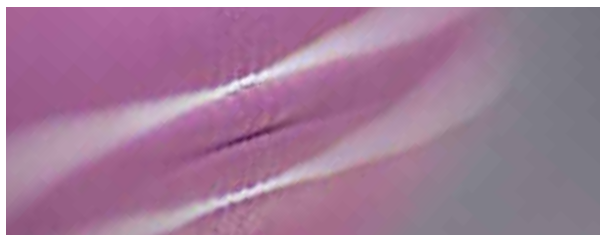

(Multi-)Color-upholstery

For the table models with this symbol, two or three colors can be selected from our various trendy colors and combined in a multi-color upholstery. You can find our color charts with the current collection on page 25 of the catalog.



Logo embroidery

Treatment beds with this symbol have the option of having your logo embroidered into the upholstery or the neck rest. Only possible with synthetic leather upholstery.



Multifunctional Headrest

The special headrest holder allows a variety of individual settings thanks to its double-joint system, which can not be achieved with a normal headrest. In conjunction with the separately available head sections, this makes almost every treatment in the head area possible. The following attachments are available:

Crescent headrest

This headrest made of soft, washable PU, is ideal for cosmetic treatments, because the areas of the throat, neck, and shoulders are completely free and can thus be treated comfortably. At the same time, the customer's head is held in a comfortable and stable fashion. Also ideal for permanent makeup and foot care/podiatry!

U-shaped headrest

With washable synthetic leather, soft upholstery. Both headrests can only be used in conjunction with the multifunctional mounting. Ideal for back massages!



Crescent headrest



U-shaped headrest

Accessories for multifunctional headrest

- Synthetic leather cover for crescent headrest, Art. 48005 ---
- 10 single-use covers for crescent headrest, Art. 75236 ---
- Terrycloth cover for U-headrest, Art. 45018 ---

Table Options



XL Extension

This clever alternative to the conventional headrest allows individual adaptation to each customer: Simply remove the standard headrest and replace it with the XL Extension. This way both slimmer and wider individuals can be treated in a fashion that is ergonomically best for them. This is particularly useful in the massage position because the XL Extension serves as a support surface for the arms. The XL Extension can of course also be adjusted by simply pulling it out. For the SLXP and SPL treatment beds, the XL Extension is also available with a face cradle! (Not available with soft upholstery!)



Color XL Extension

The XL extension can of course also come in a color from our current collection, as can the table itself. You can find our color charts at page 25.



Color Basic

Color casing

A treatment bed with this symbol is also available with the base, in addition to the standard white, in titanium-colored casing.



Casing in titanium

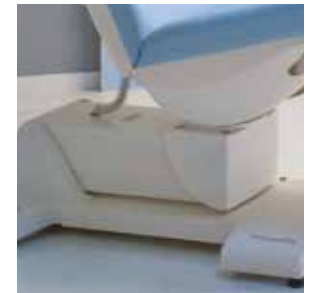

White standard Casing

Special coating of the metal parts

A special coating of the metal parts in RAL colors is possible in models with this symbol. The colors black-brown, white, and titanium (RAL 9007) are included in the table price.



Spa Ambience Light

Present your spa table in the proper light! This symbol indicates tables with hidden LED bar at the base. The indirect lighting creates an atmospheric ambience. With most tables you can choose from eight different light colors as well as an automatic color change at the push of a button.



Wood Decor

Most of our spa tables are available standard in wenge-pattern or white. For tables with this symbol, you can also select your own favorite decor and before you know it, your table will be a perfect fit for your space! Ask for our current decor palette or visit our website at:

www.gharieni.de/farbpalette-holzdecore

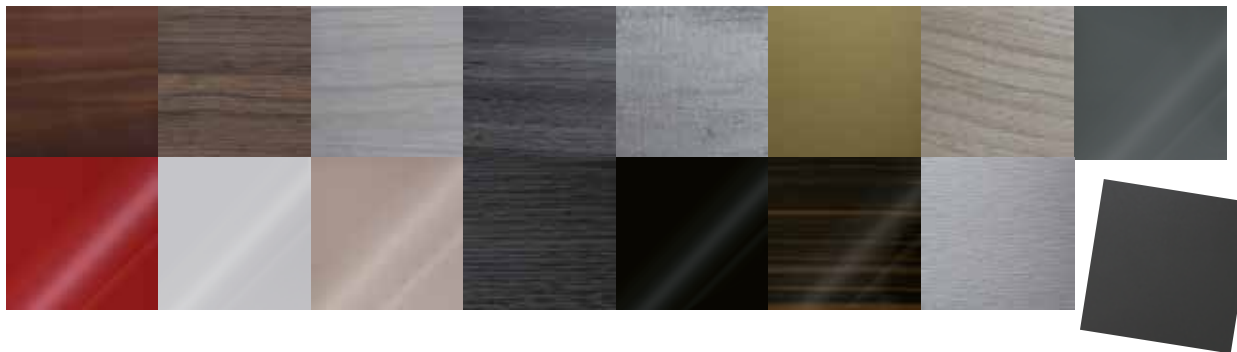

Rotonde

The Rotonde function enables treatment beds to be rotated to the left or right a total 330°. Due to this rotation, the customer can be easily put into the ideal position during treatment. By means of a side lever, the desired position of the table can be determined and also released again. 360° rotation is possible with our hydraulic models. Here the Rotonde function is included for technical reasons.



Castors

Additional castors

Treatment beds with this symbol can be equipped with braked castors. This makes it possible to easily move the table.



Electrically retractable castors

Instead of the mechanical castor mechanism, our spa tables with this symbol are also available with electrically extendable castors. These are controlled via the table's manual switch. That means: Mobility at the push of a button; it doesn't get any easier!



Table Options



Foot Switch

Depending on the table model, foot switches with different functions can be used.

For example, on the MO1, MLW F1, and SPL all actuators and memory positions can be programmed and accessed with the memory foot switch.

Models such as the MLW or MLK use a footswitch to control the basic functions.



Foot switch with memory function



Foot switch for basic functions



IR Remote Control

For table models with this symbol, a wireless infrared remote control is available. This allows the table positions to be retrieved even at a greater distance, wherein the functions correspond to the wired manual switch.



Memory Remote Control

These tables can be optionally equipped with a memory manual switch, which allows up to four or eight individual positions to be stored. A simple manual switch to operate the basic functions is included with the equipment by default.



Aroma Therapy

Enveloped by pleasant scents during treatment - with the Aroma Therapy option you can turn your treatment into a wellness experience for all the senses.

Depending on the table model, you can release aromas from one or three integrated fragrance chambers at the push of a button. The fragrances can be exchanged as desired.



Multimedia

Multimedia sound system

The sound experience for your table! The built-in audio interface offers a modern interface between many playback devices and your spa table. With the speaker integrated into the table, customers can relax to their own favorite music. At the touch of a button, you can choose between targeted playback on the head area or the entire room. Connection options: Bluetooth, SD card, USB, AUX, and iPhone.



Audio-Relax-Headrest

Speakers integrated invisibly into the headrest guarantee a pleasantly relaxing sound experience with maximum comfort. The supplied MP3 player is attached to the outside of the upholstery so that it is easy to use at any time. Around 50 minutes of GEMA free relaxation music have already been loaded onto it. The player can also be reloaded via USB connection.

Gharieni Color Charts

PU upholstery colors



Synthetic leather upholstery colors

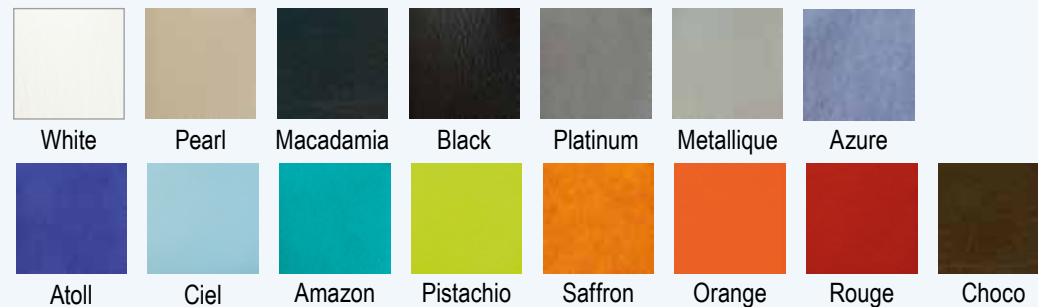

Serge Ferrari Color Charts



"Stamskin Top" synthetic leather



"Stamskin One" synthetic leather



In order to withstand even the most demanding environments (outdoor, medical, yachting, etc.), the innovative new product Stamskin One impresses with unique technical features and an incomparable finish.

Thanks to Serge Ferrari's elastomer technology, Stamskin One is particularly easy to clean and disinfect. The breathable surface is resistant to oils (massage oils, sunscreen, etc.), body fluids, and substances containing alcohol (detergents).

Wellness Concepts

Psammo Concept



MLX Quartz

Wellmassage4D



MLX 4D

Spa.Wave



MLW Amphibia

Infrared Warmth

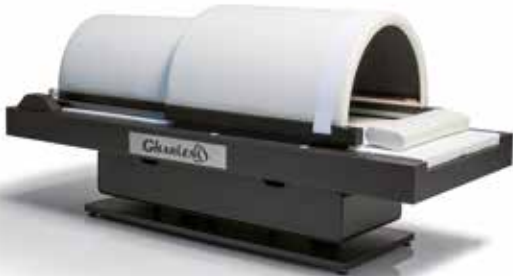

MLX Dôme

Severin*s Resort & Spa

Sylt, Germany



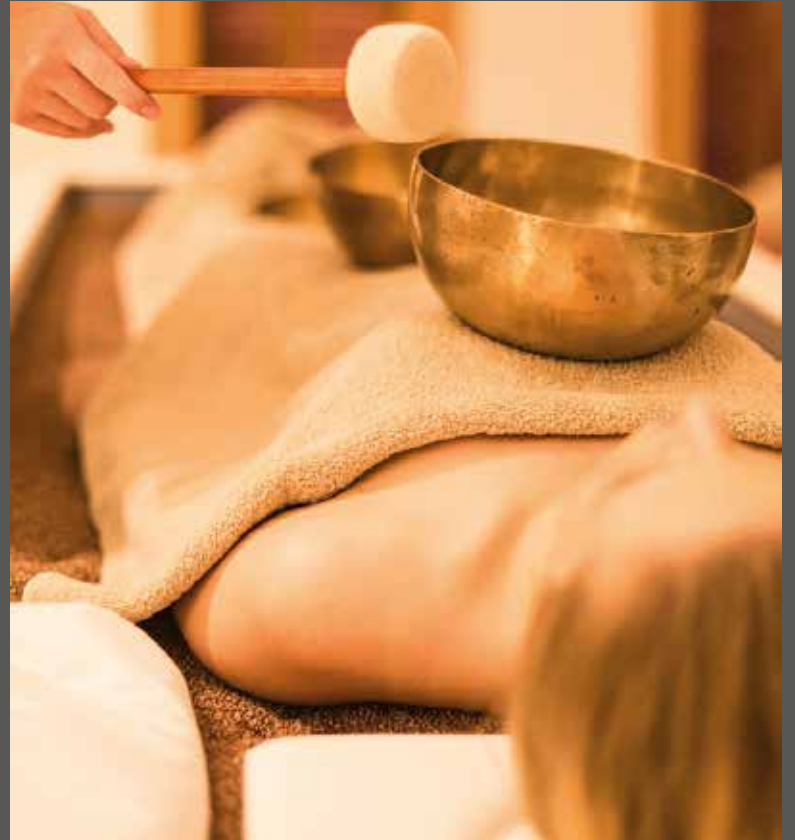

Photos: © Severin's Resort & Spa

Psammo Concept



MLX Quartz

Warm sand for body and soul – Psammo therapy (from the Greek psammo = sand) is a tradition going back thousands of years. Because the gentle, deeply effective warmth provides pure relaxation and stimulates metabolism and detoxifies. The Psammo concept from Gharieni offers you these advantages in an innovative design.

As a massage, treatment, and lounger, the MLX Quartz with its continuously adjustable alpha quartz sand combines all the possibilities for you. This allows poultices and many other applications to be carried out with little effort and high degree of efficiency. In addition, the sand table can combine numerous treatments and special signature treatments of high quality; And last but not least, the massage/treatment results are significantly increased by the deep warming. Whether it's with the MLX Quartz Round or Square quartz sand table - pamper your customers with this natural wellness treatment and offer a "quick getaway in the meantime."

Features:

- Made of real wood
- Filled with alpha quartz sand
- Continuously adjustable heating system
- Intense deep relaxation through mild, long-lasting warmth
- Two lifting columns for height and inclination adjustment
- Storage compartment and two drawers in the base
- Integrated facial surface made from soft PU upholstery
- Optional, foldable upholstery overlay for massages
- Standard upholstery color: White. Other colors from our color collection for an additional charge
- Optional scent diffuser (see page 34)
- Optional Dynamic Flow System (see page 36)



- Height: approx. 65-90 cm
- Length: 216 cm
- Square XL length: 226 cm
- Width: 86 cm
- (Recommended) lifting capacity: 130 kg
- Load capacity of the table surface: 150 kg



MLX Quartz Square

Standard wood	---
Walnut	---

MLX Quartz Square XL (+10 cm)

Standard wood	---
Walnut	---



MLX Quartz Round

Standard wood	---
Walnut	---

Psammo Concept



The two lifting columns of the MLX Quartz allow for easy height and inclination adjustment, allowing you to safely and easily operate the table from any position via the desk panels integrated in the table frame and the touch display. The adjustable height of 65-90 cm allows back-friendly working; and the inclination of the MLX to the zero-gravity position offers effective possibilities, especially with massage treatments of the back and shoulder area. In addition,

this inclination adjustment of the table for your customers has a pressure-relieving effect on the head and back as well as a mobilizing effect on blood circulation.

The warm alpha quartz sand offers more than "just" a spa experience, with personalized color mixes for custom signature treatments and table looks available on request.

Quartz Varieties

We offer you four different quartz sand fillings for the MLX Quartz:

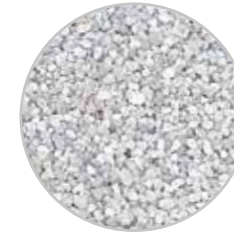

Standard



Gold

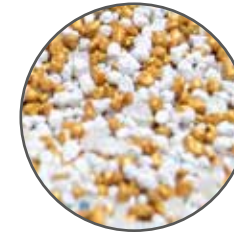

Golden Rain

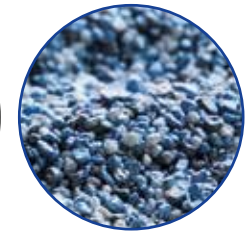

Solid Ocean

Quartz varieties, 180 kg

Standard	included.
Gold	Additional charge -,-
Golden Rain	Additional charge -,-
Solid Ocean	Additional charge -,-

Additions

The following additions can be added to the quartz mixtures (see next page):

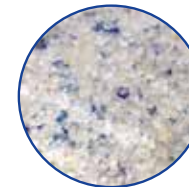

Persian Treasure



Himalayan Touch



Baltic Sunset

Persian Treasure



Persian blue salt is among the rarest rock salts on Earth and is therefore particularly precious. The salt crystals shimmer in harmonizing, relaxing shades of blue – from delicate aquamarine to dark sapphire blue. In addition, other beneficial effects are attributed to the "color of the sky." Blue is said to have a psychologically and physically balancing effect, both soothing and regenerating. The released ions of the salt also have a positive effect on the respiratory tract. In the blend with natural alpha quartz sand, Persian blue salt gives all treatments a particularly sophisticated and exclusive touch.

Blue salt + Standard quartz	---
Blue salt + Golden Rain or Gold	---
Blue salt + Solid Ocean	---

Himalayan Touch

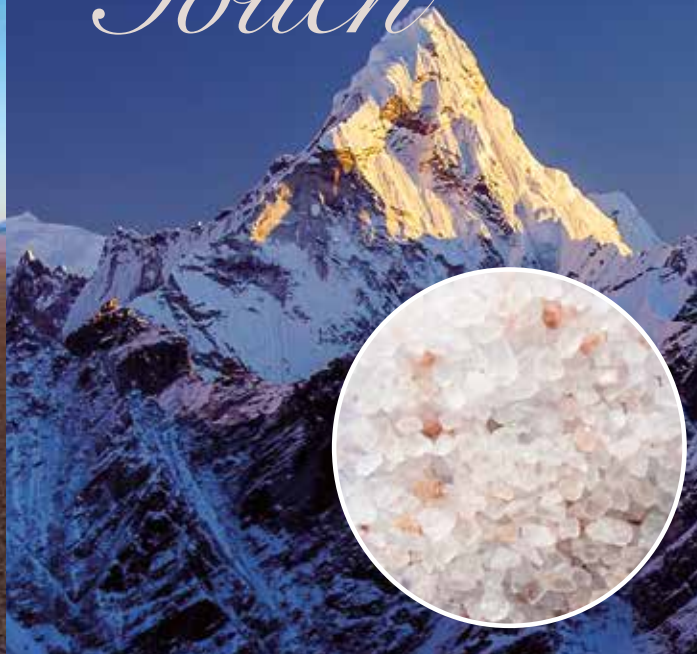

The mixture of quartz sand and Himalayan rock salt brings the soothing microclimate as we know it from mountains, coast, and forests into your treatment room! The continuously adjustable heating of the quartz salt mixture releases the ions of the salt. Once ionized in this way, the air increases respiration oxygenation and this has positive effects on the whole body as well as on the psyche. These include:

- general refreshment and vitalization
- physical relaxation and easing of tension
- spiritual calming
- metabolic stimulation
- immune system stimulation

Himalayan salt + Standard quartz	---
Himalayan salt + Golden Rain or Gold	---
Himalayan salt + Solid Ocean	---

Baltic Sunset



The mix of quartz sand and high quality Baltic amber uses the soothing powers of the "Gold from the Baltic Sea." As a stone of security, trust, and "salvation," Amber is credited with the following effects:

- spiritual harmonization
- an energizing effect
- a balancing effect on the hormone balance
- an increase in the joy of life
- detoxification of the body
- anti-inflammatory effects – also on the skin
- support of the immune system

This mixture is recommended for extraordinary Signature and Thalasso treatment.

Amber + Standard quartz	---
Amber + Golden Rain or Gold	---
Amber + Solid Ocean	---

Psammo Concept

Scent Diffuser

Lying on warm quartz sand, carried away by heavenly scents into a world of comforting relaxation? That too is possible with the MLX Quartz! Because the innovative Essential Oil Function literally offers a fragrant equipment plus. The function with its three integrated fragrance chambers – like all other table extras – is easily controlled via the touch display. However, you do not have to limit yourself to just one essential oil. Thanks to the individual fragrance chambers, you can combine up to three fragrances. With these individual, ethereal fragrance compositions, your treatments will be an unforgettable experience!

Scent diffuser for aroma therapy



Easily control the essential oil feature via the integrated, intuitive touch screen.



Facial surface

The facial surface with face cradle is extremely practical for all treatments in prone position.



Optional upholstery overlay

With this upholstery overlay, the MLX Quartz can be turned into a "normal" massage table in no time at all. The four-piece upholstery is foldable and can be stored away to save space.



Cushions and covers





Our exclusive accessory set consists of various cushions and covers. The extensive set allows you to optimize your work perfectly.



Illuminated base

The concealed LED strip under the table surface provides a light accent in your desired color on the MLX quartz. In addition, it creates an atmospheric lighting in your workspace.

Options (more info. after page 20)

- 
 Color upholstery: max. 2 different colors
 PU, each color -.-
 Synthetic leather standard, per color -.-
 Synthetic leather Ferrari Stamskin Top, per color -.-
- 
 Metal parts in special colors (white, titanium, or dark brown are included in the table price) -.-
- 
 Other woods and paints -.-
- 
 Spa Ambience Light: Base with LED lighting -.-
- 
 Aroma therapy -.-

Accessories (see also page 154)

- Standard upholstery cover, white (Additional color charge, see options) -.-
- Maxi accessory set for MLX Quartz
 consisting of: Sand poultice warmer, 7 sand poultices of var. sizes, storage cushions, shoulder cushions, oil massage sheets, small pelvis bowl, small heart bowl, gel ring, Dentalax neck rest, and slotted tissues for face cradle -.-

Psammo Concept

Sand in Motion

Dynamic Flow System

For special types of massages

The innovative MLX Quartz sand spa table is available with the exclusive Dynamic Flow System - for even more intensive and efficient treatments:

Air chambers integrated into the table, which are pre-programmed to fill with air and empty out, move the pleasantly warm quartz sand around. This way, even without therapists, your customers will experience a soothing back massage, which relaxes the muscles and mobilizes the body as a whole.

For a massage treatments by a therapist, the MLX Quartz and the Dynamic Flow System offer a 360°-treatment: The controlled-temperature sand warms the body, while the gentle movement from below support the massage of the practitioner from above. An extraordinary, all-round relaxation experience for your customers!

Dynamic Flow System

--



The Dynamic Flow System...

...shifts the sand in the area of the back in gentle, wavy movements. These have a pleasant and relaxing effect.

Quartz Poultice

They are an excellent enhancement for treatment on the MLX Quartz. Because you can perform various heat treatments with the sand poultices in different sizes. The individual sand poultices can be found in our Medical, Feet & Care catalog.



Quartz Poultice Warmer

including 10 quartz poultices

The Gharieni quartz poultice warmer ensures a constant temperature for the quartz poultices. The heating system can be easily controlled from the front panel and an LED indicator provides information on the temperature status. The design of the real wood frame is adapted to the MLX series and is a perfect complement for your ambience. In addition, the included cover not only ensures efficient heat storage, but is also great to use as a tray for the sand poultices.

Features:

- Table device for keeping the sand poultices warm
- Made of real wood
- Filled with alpha quartz sand
- Continuously adjustable heating system
- including four large, two medium, and four small sand poultices



- Height: approx. 24 cm
- Length: 63,5 cm
- Width: 23,5 cm

Quartz Poultice Warmer

Incl. 10 Quartz poultices, of var. sizes



Filled with quartz sand

Like the MLX Quartz, the poultice warmer is also filled with alpha quartz sand. This guarantees a uniform and sustainable heat release.



No unnecessary heat loss

The device's practical cover panel prevents heat loss inside. In addition, it can also be used as a tray.



Galgorm Resort & Spa Ballymena, Northern Ireland



Wellmassage4D



MLX Wellmassage4D

The innovative treatment concept

Up to now, you were only familiar with massages where customers are lying flat. With WellMassage4D that's now completely different! This signature treatment was created in collaboration with Jean-Guy de Gabriac, CEO of the Belgian massage and spa specialist Tip Touch International, especially for the MLX spa table.

The unique treatment concept combines high-tech & high touch to create high impact. With its innovative mix of strokes, pressure massage, sliding massage strokes, and mobilization and meridian stimulation in combination with eight programmed table positions, the WellMassage4D offers an extraordinary full-body treatment for sustained deep relaxation.

You will learn the innovative treatment concept in our Well-Massage4D training course, where the eight special table positions are also explained and saved.

MLX Features:

- Exclusive designer table for spa and wellness
- Four actuators for electrical adjustment of height, back, leg, and foot sections
- Face cradle
- Two removable arm pads
- Trendelenburg feature
- Eight treatment positions can be saved
- Locking feature
- Soft, robust PU upholstery
- Also available in synthetic leather
- Optional soft upholstery
- Standard upholstery color: White. Other colors from our color collection for an additional charge
- Base in white or wenge, optional in other decors
- Large storage space
- Full-length large drawer or two small drawers and a folding compartment



- Height: approx. 58-98 cm
- Length: 203 cm
- Width: 85 cm
- Upholstery width: 80 cm
- (Recommended) lifting capacity: 300 kg
- Load capacity of the table surface: 350 kg



MLX

Wellmassage4D-Edition



The award-winning treatment concept

Three awards all went to WellMassage4D in 2016: We received the innovation prize from the German Wellness Association and the European Spa Association; and Spa & Wellness México honored our innovative treatment concept with its Product Award.





Step by Step

The WellMassage4D in eight steps

With the WellMassage4D with its eight special treatment steps, the perfect flexibility of our high-tech MLX spa table is fully utilized. With unique motion sequences and pre-set positions, MLX offers treatment options unlike any other spa table!

The combination of high tech & high touch ensures a unique spa and relaxation experience. At the same time, it offers the therapist the opportunity to work ergonomically in the best possible way, i.e. back-friendly and saving their strength.

WellMassage4D can be run as 50- and 80-minute treatments in two versions:

"RELAX"

The deep relaxing effect of this program lets your customers forget the stress of everyday life.

"DEEP"

The focus of this program version is on the additional relaxation of stress-related tense, aching muscles.



Position 1

At the beginning, the customer assumes the classic massage position to "arrive" and to tune in to the subsequent symphony of touch.



Position 2

The elevation of the back by 40° and slight angling of the legs relieves the area of the lumbar spine. At the same time, the head, neck, and shoulder girdle are relaxed. This position allows the therapist to give a gentle pressure massage.



Position 5

Lower legs and feet are elevated above chest height. This allows the foot reflex zones to be massaged.



Position 6

The legs are moved one step higher and the back is positioned a bit lower. This supports the return of the venous blood as well as the lymph from the lower extremities.



Position 3

The knees remain in the same position while the back is lowered by 10°. This allows the therapist to treat the customer's hands, arms, and shoulder blades as well as their lower back and upper torso right up to the waist in a way that rests the back.



Position 4

While the position of the back remains unchanged, the angle of the knees is increased. This shifts the weight of the thighs to the hips and relaxes the thigh muscles. It can now be treated effectively with significantly less effort.



Position 7

The elevation of the back and lower leg support prepares the customer gently for the end of the treatment and stimulates their circulation.



Position 8

The customer spends a few minutes more relaxed in a sitting position, then they can easily get up from the bed.

Options (more info. after page 20)

-  Smart-Thermo: programmable heating system with automatic shut-off ---
-  Color upholstery PU: max. 2 different colors possible, per color ---
-  Audio-Relax-Headrest: with integrated speakers to connect to common players ---
-  Metal parts in special colors (white, titanium, or dark brown are included in the table price) ---
-  Decor surfaces our collection, (White and wenge are included in the table price) ---
-  Foot switch memory function: for controlling the basic functions and the memory positions ---
-  IR Handheld remote control: wireless operation for controlling the table ---
-  Spa Ambience Light: Base with LED lighting ---

Accessories (see also page 154)

- Dentalax neck rest, PU ---
- Gel cushions for the face cradle ---
- Terrycloth (white, macchiato, or choco) ---
- Foot protective cover, PVC, transparent ---
- PU protective cover, Art. 49051 ---

JW Marriott Miami Turnberry Resort & Spa
Miami, USA





Spa.Wave

Binaural Acoustic & Dynamic Stimulation





Targeted stimulation of brain waves

Healing in harmony
with body, mind and nature

Deep relaxation
with added value

The exclusive sound massage system

Anti-stress experience

Spa.Wave – The Binaural Acoustic & Dynamic Stimulation – combines the gentle sound waves of a special music with a highly efficient vibration massage system integrated in the table surface. While the special sounds soothe the mental activity, the vibration massage specifically affects the energy centers (chakras) of the body. Thus, this innovative sound massage system combines the effects of deep relaxation techniques with those of meditation and mindfulness practice. In this way, Spa.Wave offers a very exceptional and particularly effective relaxation and anti-stress experience.

Waves make the difference

The electrical impulses of brain cells reveals whether our brain is in the waking or resting state. They can be measured as brainwaves with different frequencies in brain wave curves. Thus, our semi-sleep and our state during light meditation are both characterized by low-frequency alpha waves. Theta waves can be found during the sleep and dream phases, as well as in deep meditation. If our brain waves vibrate in the alpha or theta modes, we are in a state of deep relaxation. Delta waves on the other hand determine deep sleep. Our self-healing powers become active during this phase.

Relaxation – better than sleeping!

The Spa.Wave system uses the soothing power of the slow, evenly vibrating brainwaves very specifically. The basic technology here is Quantum Harmonic Audio Therapy: Special music with binaural tones (two simultaneously very slightly different frequencies) generates gentle sound waves in time to a calm heartbeat. They stimulate the brain and put it in alpha to delta mode. This way body, mind, and soul find deep, soothing, and regenerating rest.

Far more than relaxation!

If brain waves oscillate in the alpha to delta or theta mode, the deep inner peace it generates has an effect not only on the soul, but on the entire organism. Because as a "control center," our brain also regulates the autonomic nervous system and thus our organ functions. The positive effects:

- Heart rate and pulse rate slow down, blood pressure drops.
- Breathing becomes deeper and calmer.
- The muscles relax.
- Blood vessels dilate, which increases the blood flow.
- The production of stress hormones is reduced.
- The immune system is activated.

With the Spa.Wave system, all these beneficial effects can be achieved within a very short time.

An optimal combination

If the sounds of the Spa.Wave put the brain into relaxation mode, the fine vibrations of the integrated vibration massage system harmonize with the body's energy centers (chakras). Thus, the Spa.Wave allows for rapid, unique, mental as well as physical relaxation and regeneration. As a perfect complete system it offers the ultimate way to:

- Recovery
- Refreshment
- Vitalization

Scientists are convinced!

Clinical studies from the US confirm the effectiveness of the Quantum Harmonic Audio Therapy on which the Spa.Wave system is based. The scientists also found that the specific sound frequencies are suitable for a wide range of applications:

- As little as one single session can reduce everyday and work-related stress.
- Within 14 days, sleep quality and quantity improve by up to 80 percent.
- Anxieties and depressive symptoms, as well as psychological effects of trauma, are reduced by 40 to 60 percent.
- The psychological consequences of persistent pain diminish.

Soothing versatile effects

Easy to use.

Proven effectiveness

Sound & Vibration

for body, mind, and soul



The features of the Spa.Wave are controlled by the intuitive touch display.



Domaine La Butte aux Bois
Lanaken, Belgium



Photos: © La Butte aux Bois / Hugo Thomassen

MLX Dôme



MLX Dôme

Long-wave infrared rays stimulate the metabolism and thus the perspiration of the body. – An effect that can be specifically used within the extendable heat dome of the MLX Dôme. In addition, the infrared radiation generates a pleasant warmth, and thus increases well-being.

The MLX Dôme can not only be used as an infrared sauna, but also for facials. This is made possible by the height-adjustable table surface, which allows the customer to move to the perfect working height.

Features:

- Extendable heat dome
- Opening dome electrically
- Special warming technology
- Height-adjustable
- Spacious drawer
- Combo-table: Facials possible during heat treatment
- Standard upholstery color: White. Other colors from our color collection for an additional charge
- Base in white or wenge, optional in other decors
- Including neck cushions

MLX Dôme

Including Neck cushion



- Table surface height: approx. 57-97 cm
- Length: 225 cm
- Width overall: 90 cm
- Table surface width: 70 cm
- (Recommended) lifting capacity: 300 kg
- Load capacity of the table surface: 350 kg

MLX Dôme

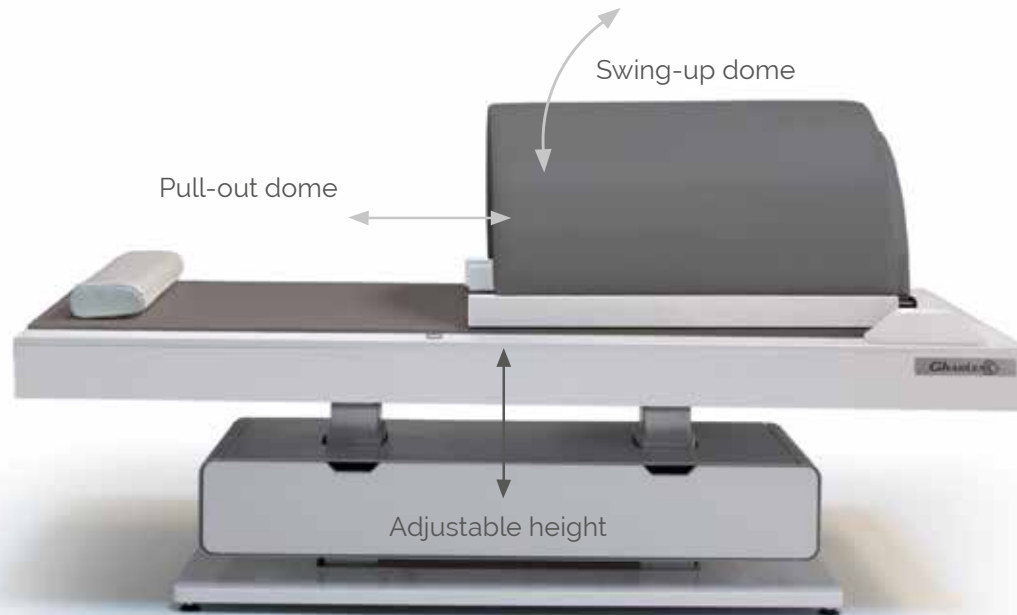

The MLX Dôme has numerous features. By means of its height adjustment, a low entry height of about 57 cm can be achieved along with a maximum working height of 97 cm.

For easy access, the dome can be opened electrically and pushed together manually.





Swing-up dome

So getting into the heat dome isn't an issue: The dome can be raised electrically when it is retracted by simply pressing a button via a control panel mounted next to the table surface.



Oxygen option

Optionally, a device can be integrated into the MLX Dôme for oxygen enrichment. Through a flexible tube, the outlet nozzle for O₂ inhalation can be positioned directly on the nose.

Options (more info. after page 20)



Color upholstery PU:
max. 2 different colors possible, per color



Decor surfaces: our collection,
(White and wenge are included in the table price)

Accessories (see also page 154)

Oxygen option



Tension strap for towels

To increase the effect of the IR sauna, a towel can be attached at the open side with a strap. This will keep even more heat inside the dome.

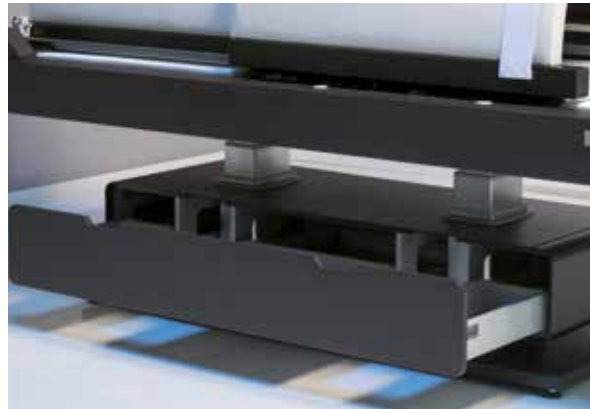

Storage space

On the MLX Dôme, a spacious drawer beneath the table surface features enough space for towels, work instruments, and much more.

HydroSpa



PediSpa Square



PediSpa Compact



PediSpa Curve



Hair Swing



Libra Edge



MLR Wet



V-Box



Jet Shower

PediSpa Square



PediSpa Square

More than a foot spa! Whether pedicure, manicure, cosmetics, makeup, or hair care: the PediSpa Square offers a wide range of treatment options thus making it a real all-rounder! Highest demands on functionality, quality, and design make this model with its base made of high-end Corian® the ultimate premium treatment unit.

The following equipment versions are available from the PediSpa:

PediSpa Square Basic

- Manual or mechanical water control via Symetrics handles or controls
- Pouring tube

PediSpa Square Comfort

- Electronic water control via SMART TOOLS
- Pouring tube

PediSpa Square Superior

- Electronic water control via SMART TOOLS
- Pouring tube
- Automatic filling via the pouring tube
- SPA programs: Vitalize & Relax

PediSpa Square Deluxe

- Electronic water control via SMART TOOLS
- Pouring tube
- Automatic filling via the Water Fall with Pearlstream
- SPA programs: Vitalize & Relax

Features:

- Base made from high-quality Corian®
- Height-adjustable footrest
- Comfortable seat with many adjustment options
- Two possible headrest versions: removable **or** inclinable
- Seat upholstery in two strengths
- Upholstery made from synthetic leather
- Standard upholstery color: White. Other colors from our color collection for an additional charge
- Two armrests selectable
- Optional: higher armrests with integrated tray

PediSpa Square

Basic	---
Comfort	---
Superior	---
Deluxe	---
Armrest with folding tray	---

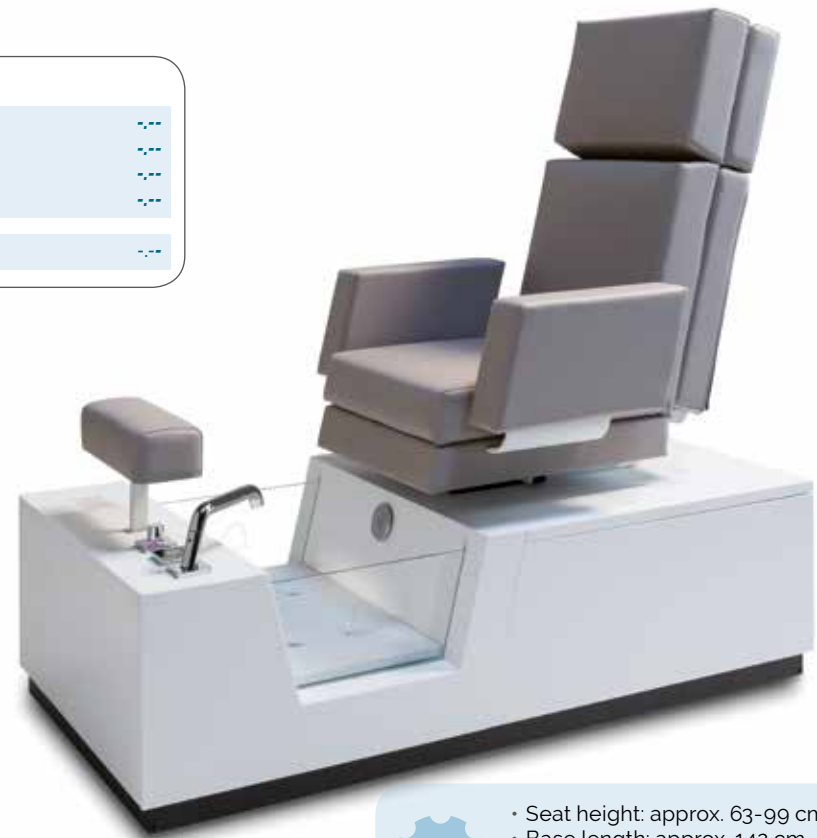

- Seat height: approx. 63-99 cm
- Base length: approx. 142 cm
- Width: approx. 76 cm max.
- (Recommended) lifting capacity: 130 kg
- Load capacity of the table surface: 150 kg

PediSpa Square

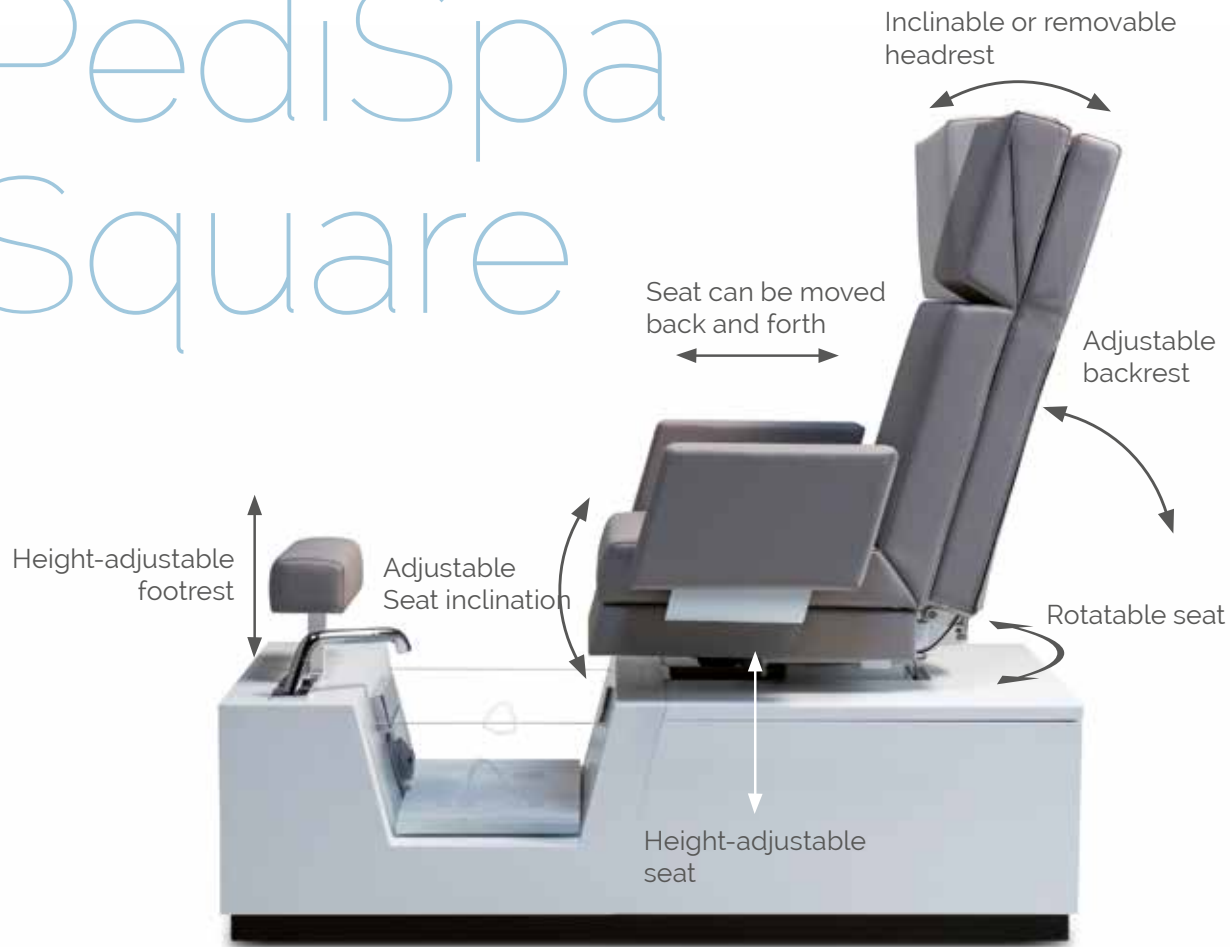

Extremely flexible

The PediSpa Square has a variety of adjustment options that make a treatment comfortable:

In addition to the headrest which swivels forward by 25°, the backrest can be tilted back by up to 75°. The seat is electrically height adjustable from 63-99 cm, tiltable by 14°, and

can be moved 17 cm forward and backward. The footrest can also be easily adjusted at the touch of a button by up to 21 cm in height. The swivel function of the seat ensures easy access – 90° to both the left and right.

5 in 1

PEDICURE
MANICURE
FACIAL
HAIR CARE
MAKEUP



Pedicure

1

A rotatable seat, the adjustable seat distance to the foot basin, a height-adjustable footrest, and easy-to-use fittings – this is foot care in a class of its own.



Manicure bowl + folding tray

2

Practical options for manicure: The fold-out trays integrated into the armrests, as well as the flexible manicure bowl, make hand and nail care on PediSpa Square child's play.



Cosmetics

3

The backrest, which can be tilted by up to 75°, enables a low reclining position for the customer – perfect for cosmetic treatments.



Hair care

4

Care from head to toes! Together with the Hair Swing basin, the PediSpa Square with removable headrest also makes hair care easy.



Makeup

5

Simply put the seat in a lateral position, remove the headrest (option!), and move the chair to the appropriate height – Ready for makeup!

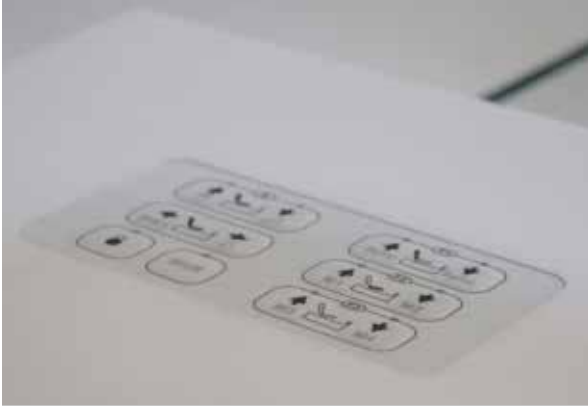

Membrane panel

The membrane control panel, which is set into the Corian® at the front of the table base, allows for particularly easy handling of the treatment chair.



Removable headrest

The PediSpa Square is also available with a removable headrest. This equipment version is recommended for all hair treatments.



Exchangeable seat upholstery

The optional Comfort upholstery (pictured left) is made of durable, hygienic PU and is very soft. This allows customers to enjoy their treatments even more relaxed.



Corian® versions

The precious mineral material Corian® fulfills all color and structure wishes. Thus, the base of the PediSpa Square can be visually adapted to any interior and ambience.

Options (more info. after page 20)



Color upholstery: max. 2 different colors possible
Synthetic leather standard, per color ---
Synthetic leather Ferrari Stamskin Top, per color ---



Metal parts in a special colors (white, titanium, or dark brown are included in the table price) ---



Corian® surfaces our collection,
(White is included in the table price) ---

Accessories

Neck cushion, white ---

Neck cushion, in colors ---



Equipment Versions

SPA programs: Vitalize & Relax for PediSpa SUPERIOR and DELUXE.

The FOOT BATH^{ATT} from Dornbracht combines different spray modes, comfort functions, and pre-programmed scenarios. Each of their effects remains noticeable long after use.

There are two scenarios to choose from in the FOOT BATH^{ATT}:



FOOT BATH^{ATT} scenario 1: VITALIZE

This program refreshes, invigorates, and gives new energy. Four nozzles massage the reflex zones on the soles of the feet with increasing pressure intensity and changing temperatures.



FOOT BATH^{ATT} scenario 2: RELAX

This scenario stimulates, relaxes, and warms. After the feet are immersed in the warm, shallow water, the temperature and water levels rise slowly, until the customer leaves the foot bath after 10 minutes.

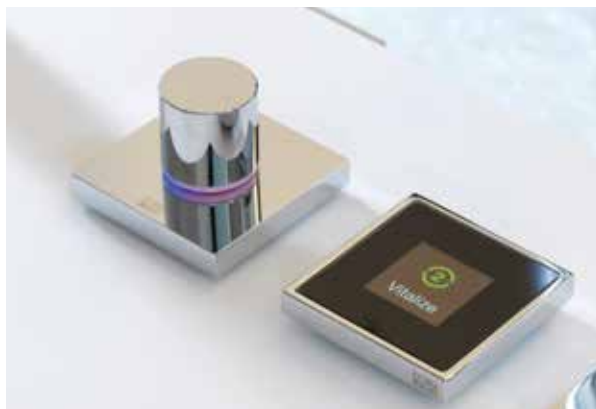

SMART TOOLS

Operating the FOOT BATH^{ATT} is simple and easy via the digital SMART TOOLS.

For PediSpa COMFORT, SUPERIOR, and DELUXE.



Pouring Tube

The pull-out pouring tube allows for refreshing, individual Kneipp pours.

For all four PediSpa versions.



Water Fall Filling

The pool is automatically filled with fresh sparkling water via the Water Fall with Pearlstream.

For PediSpa DELUXE.

PediSpa Compact



PediSpa Compact

With our PediSpa models, you can not only work perfectly professionally, but the foot bath also becomes a special wellness experience. Because these treatment tables offer exceptionally comfortable seating. The space saver among the PediSpas is the PediSpa Compact, which is permanently installed on the floor and has an integrated water inlet and outlet as well as a pull-out hand shower. Its basin is covered by the frame as soon as the seat is pushed forward. In addition, the little step on the front can be pulled out. Featuring a non-slip surface, customers can comfortably and safely be seated and also "descend" back down again. In addition, the PediSpa Compact is available with two armrests: standard with low armrests or optionally with high armrests, each of which can be equipped with an integrated folding tray.

Features:

- Two-part base
- Seating area completely movable to the rear
- Foot basin made of high quality Corian® securely installed on the floor
- When the seat is pushed forward, the basin is covered by the frame
- Compact construction
- Adjustable backrest
- Two possible headrest versions: removable **or** inclinable
- Height-adjustable footrest
- Upholstery made from synthetic leather
- Standard upholstery color: White. Other colors from our color collection for an additional charge
- Basin with pull-out hand shower, integrated water inlet and drain
- Optionally with Pipeless Massage
- If there is no connection to the ground, the installation of a drainage pump is possible
- Optionally with a folding tray integrated in the armrest
- Retractable, non-slip step on the front



- Base length (retracted): approx. 80 cm
- Base length (retracted): approx. 150 cm
- Overall width including armrests: approx. 86 cm
- Base width: approx. 80 cm



PediSpa Compact

Standard	---
Armrest with folding tray	---
Drainage pump	---
Pipeless massage	---

PediSpa Compact



Practical in every respect

With this PediSpa, the base and seat can be pushed over the foot basin to save space. The pull-out step makes it easy for customers to take their seats and descend again; and the headrest, which can be tilted forwards by 25°, offers perfect sitting comfort.

The footrest, which can be adjusted up to 21 cm in height, allows for ergonomic working during pedicures. Thanks to the backrest, which can be tilted backwards by up to 75°, the PediSpa Compact is also perfect for use with cosmetic treatments.





Space-saving construction

This foot bath does not take up much space, because by simply moving the seat forward it is covered by the table base. In addition, a pull-out step is integrated into its front.



Removable headrest

The PediSpa Square is also available with a inclinable headrest, in addition to a removable/retractable headrest. This equipment version is recommended for all hair treatments.



Manicure bowl + folding tray

Optionally available: The fold-out trays integrated into the armrests, as well as the flexible manicure bowl, make hand and nail care on PediSpa Compact child's play.

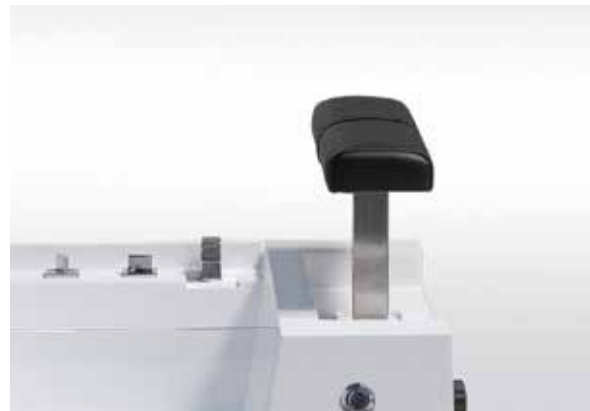

Height-adjustable footrest

Simply manually adjust the footrest to the desired height and you'll be working ergonomically in no time!

Options (more info. after page 20)

- 🔧 Color upholstery: max. 2 different colors possible
 - Synthetic leather standard, per color -.-
 - Synthetic leather Ferrari Stamskin Top, per color -.-
- 📄 Decor surfaces our collection, (White and wenge are included in the table price) -.-
- 📄 Corian® surfaces our collection, (White is included in the table price) -.-

Accessories

- Neck cushion, white -.-
- Neck cushion, in colors -.-

PediSpa Curve



PediSpa Curve

This PediSpa model features an impressive dynamic and elegant design, as well as high-quality workmanship. The height-adjustable foot section and the tiltable and removable head section are easy to handle and also make work easier. Made from the best materials, the PediSpa Curve is a real highlight for every spa, whether in the Basic or Comfort equipment version. With optional extras such as heated seats, pipeless foot massage, as well as auto-filling, the PediSpa Curve Comfort meets your customers' highest demands for exceptional treatments.

Features:

PediSpa Curve Basic

- Base partly made from high-quality Corian®
- Compact construction
- Height-adjustable footrest
- Adjustable backrest
- Headrest inclinable and removable
- Fold-out armrests removable
- Upholstery made from synthetic leather
- Optionally with heating
- Standard upholstery color: White. Other colors from our color collection for an additional charge
- With hand shower

PediSpa Curve Comfort

- Details like Basic
- Pipeless foot massage
- Auto-filling



- Base length: approx. 120 cm
- Width including armrests: approx. 80 cm
- Base width: 70 cm

PediSpa Curve

Basic

Comfort

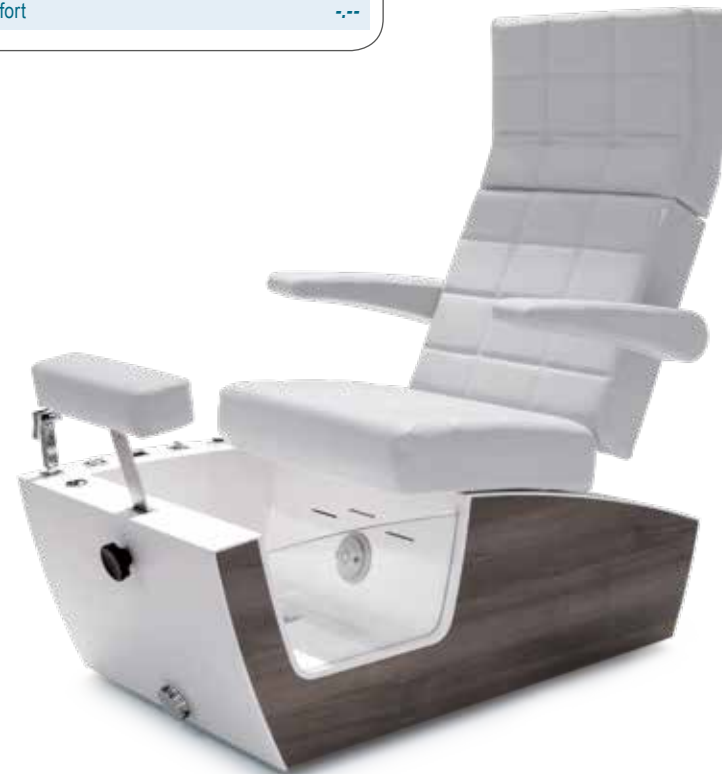

PediSpa Curve



Set-up on request

The seat, which can be moved forwards and backwards a total of approx. 17 cm and the forward-inclinable head section, ensure perfect seating comfort. In addition, the head section can also be removed. This way the PediSpa Curve is

perfect for use with all hair treatments. The armrests swivel to the rear and can also be removed; The backrest can be tilted back by up to 75° – ideal for cosmetic treatments.



Easy-to-use fittings

The elegantly designed fittings make it easy to regulate the water temperature and divert the flow of water to the shower head.



High-end wood decor

For an extraordinarily elegant look: Choose the side panel of the base in one of our numerous fine wood decors.



Footrest height-adjustable

The footrest is manually height-adjustable. This puts your customers' feet at the appropriate working height for perfect ergonomic sitting during the pedicure.



Removable head section

The head section of the PediSpa Curve can be both tilted and removed. Thus this table is also well equipped for hair care.

Options (more info. after page 20)

- 🌡️
Smart-Thermo: programmable heating system with automatic shut-off

- 🖌️
Color upholstery: max. 2 different colors possible
Synthetic leather standard, per color

- 📦
Side decor surfaces our collection, (white is included with the table price)

Accessories

- Neck cushion, white

- Neck cushion, in colors

W Amsterdam The Netherlands





Hair Swing



Hair Swing

White
Black



Washing System Hair Swing

The Hair Swing washing system is a real highlight for all hair care applications. With three articulated elements, the Hair Swing has a particularly wide radius of 120 centimeters. This allows convenient operation of two stations next to each other. The porcelain basin also offers optimal comfort with its tilting mechanism: If the washing system is not in use, it takes up little space thanks to its swivel arm supported by three bearings.

Features:

- Porcelain basin with tilting mechanism for hair washing
- Completely 360° rotatable
- Single-handle faucet row with ceramic sealing
- Hand shower with hose lead-through and shower hose in black, 100/140 cm long
- Foot color: White aluminum
- Basin color: White or black



- Maximum reach 120 cm
- High basins: 94-100 cm depending on the tilt angle



Practical hand shower

The modern, flexible hand shower with its long hose and the practical single-hand faucet allows for optimal hair care.



Flexible articulated arm

After use, the Hair Swing basin can easily be swung aside. This way you have sufficient space for your other treatments

Libra Edge



Libra Edge

This table made of stone-like, yet skin-friendly Corian® is ideal for all wet applications. Because the edge of the heated table surface and the integrated 4-point drain let the water run off even in inclined table position.

The Libra Edge Wet Table is the perfect treatment table for wet treatments, while the Libra Edge with horizontal shower guarantees an exceptional showering experience while lying down. The shower arm can be equipped with three different technologies:

1. With standard shower heads that supply water evenly and continuously. Thus the front table area and the rear area can be controlled independently.
 2. With Kohler® technology: These ensure a kind of special water choreography through a temporary, pre-programmed start and stop.
 3. With the Dornbracht® technology, your customers will experience deeply relaxing water choreographies with an additional Kneipp effect thanks to the alternating water temperature during the showering process.
- Many functions can also be accessed via an intuitive touch screen display.

Features:

Libra Edge Wet Table

- Base made from Corian®
- Table surface with air/water cushion
- Electrical height and inclination adjustment
- Integrated 4-point water drain for optimum drainage, even in an inclined position
- Optional: Heating system for table surface
- Splash guard to protect the face
- Optional: integrated steam sauna with attachable steam cover

Libra Edge with horizontal shower

- Features such as Libra Edge Wet Table
- Shower arm in three versions: with standard shower heads, with Kohler® technology, or with Dornbracht® technology, alternating water temperature
- Intuitive operation via touch screen display
- Optional: LED chromotherapy system
- Optional: Aroma capsule system for hand shower
- Optional: Kohler® Music Soundsystem
- Optional: Integrated steam sauna with steam cover

Libra Edge

- With standard horizontal shower ---
- With Kohler® technology ---
- With Dornbracht® technology ---



Libra Edge Wet Table

- Without horizontal shower ---



- Table surface height: approx. 63-100 cm
- Height including arm: approx. 190 cm
- Table surface length: approx. 203 cm
- Length including arm: approx. 236 cm
- Width: approx. 85 cm max.
- (Recommended) lifting capacity: 300 kg
- Load capacity of the table surface: 350 kg

Libra Edge

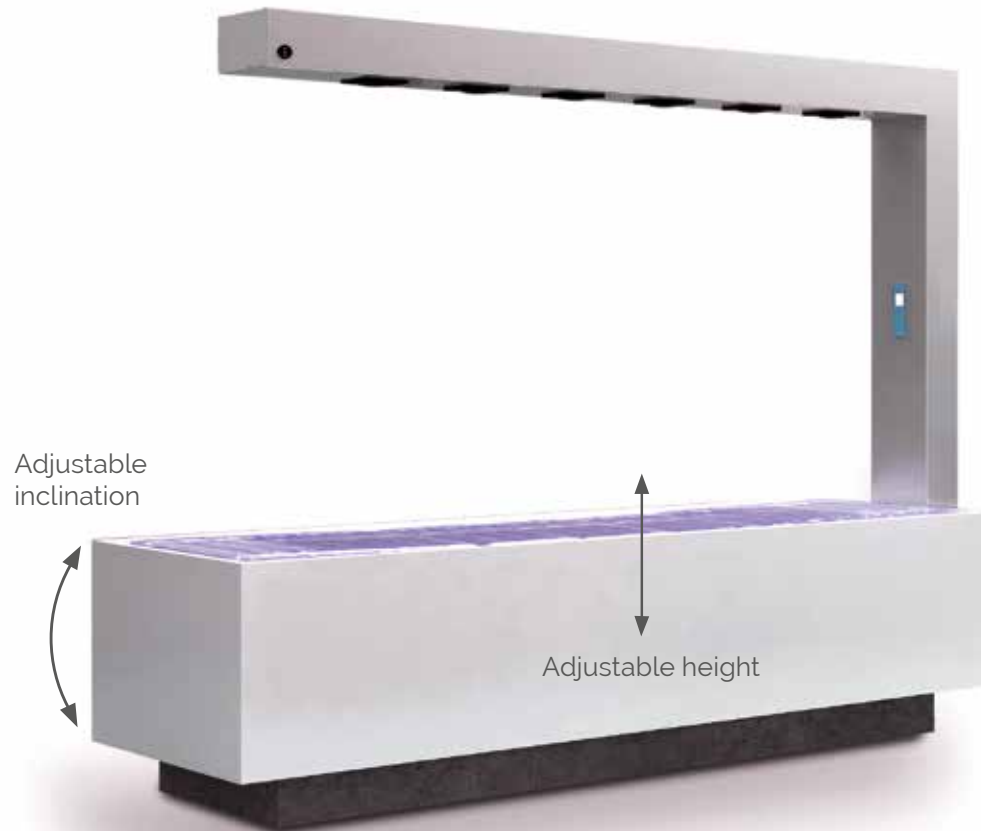

Steam sauna

With the attachable steam cover and steam nozzles integrated into the table surface, the Libra Edge can quickly and easily turn into a steam sauna.

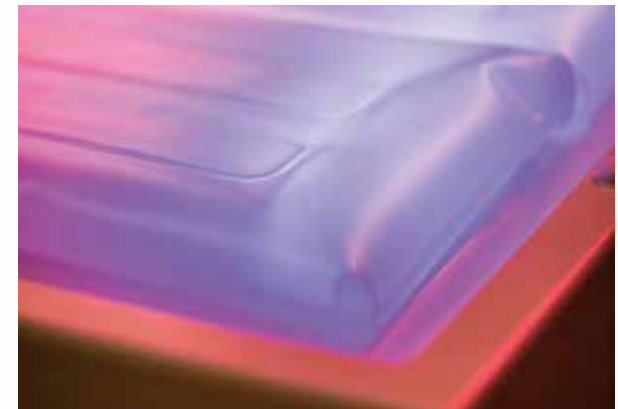

Water or air cushion

The water or air inflatable table cushions offer your customers perfect lying comfort, a relaxing waterbed feeling, and the relaxing sensation of floating on clouds.



Face Shield

We offer the Face Shield for those for whom splashing on the face is uncomfortable. In the lying position, it effectively protects the customer's face from unwanted contact with water.



Music and sound system

The optional Kohler® sound system waterproof speakers integrated into the shower arm provide relaxing sounds during treatments.

Special options

- Heating system for table surface ---
- Integrated steam sauna with attachable steam cover ---
- LED chromotherapy system ---
- Kohler® Music Soundsystem ---
- Hand shower with aroma capsule system ---



Aroma capsules

The optional aroma capsule system at the outlet of the hand shower completes the relaxing water experience perfectly: Just insert the aroma capsule and the soothingly aromatic water starts flowing.



LED lighting

The integrated LED lighting bathes the table surface and base with a changing color gradient or individually selectable shade in atmospheric light. This can also be used for chromotherapy.

Accessories

- Face Shield replacement membranes, 6 piece ---
- Aroma capsules, 10-pack with one variety, 8 different scents to choose ---

The Lamp Hotel Norrköping, Sweden





Photos: ©The Lamp Hotel

MLR Wet



MLR Wet

Be it spa treatments in the open air or wet treatments indoors at your spa – with its waterproof coating and the water-resistant materials of the base, the MLR Wet meets exactly these requirements. The purist-elegant spa table offers many electrical adjustment options, such as height, inclination, and back and foot sections. In addition, the MLR Wet is equipped with a Trendelenburg feature and optionally with a locking feature. The upholstery has a face cradle for comfortable prone body treatments.

Important note: for wet and outdoor use, the supplied waterproof cover is required!

Features:

- Exclusive wet/outdoor table
- Including two waterproof covers
- Base made from waterproof material
- Table surface with electrical height, back, leg section, and inclination adjustment
- Including removable, waterproof cover for wet treatments
- Two removable batteries for independent power supply
- Standard upholstery color: White. Other colors from our color collection for an additional charge



- Height: approx. 57-87 cm
- Length: approx. 203 cm
- Width: approx. 80 cm max.
- (Recommended) lifting capacity: 300 kg
- Load capacity of the table surface: 350 kg

MLR Wet
Including 2 waterproof covers ---



MLR Wet with waterproof cover

MLR Wet



For indoor & outdoor treatments

With its two lifting columns, the MLR Wet can be set at a height of 57-97 cm and the inclination angle of the table surface can be adjusted to +/- 15° to the Trendelenburg position. Also electrically, the back and leg area can be angled at

70° or 25°. Thus, the MLR Wet offers optimal table and working comfort for all wet indoor treatments or outdoor spa treatments.



Waterproof materials

Made with waterproof materials and a removable, waterproof cover, the MLR Wet is the ideal choice for both wet and outdoor treatments.



Trendelenburg position

This zero-gravity table position with low head and elevated foot section allows customers to relax in comfort.



Battery operation



Thanks to the battery integrated into the table, the MLR Wet can also be operated electrically independent of the power supply. It is removable and can easily be exchanged for a supplied second battery.



Waterproof cover

The water-resistant PU cover is skin-friendly, hygienic, tough, and essential for all wet treatments. The cover is available in white or choco..

Options (more info. after page 20)

- 
Color upholstery PU:
max. 2 different colors possible, per color
-.-
- 
Metal parts in special colors (white, titanium, or dark brown are included in the table price)
-.-

Accessories (see also page 154)

- Waterproof replacement cover -.-
- Replacement battery -.-
- Dentalax neck rest, PU -.-
- Gel cushions for the face cradle -.-
- Terrycloth cover -.-
- Foot protective cover, PVC, transparent -.-

V-Box



V-Box

Showering in a new dimension! The perfect complement to the MLR Wet is the V-Box, which can be installed on the wall. The horizontal shower arm with its six movable shower heads allows for an extraordinary water experience while lying down! It is available in three equipment versions – V-Box Standard, V-Box Evo, and V-Box Evo 2.

V-Box Standard

- With six movable showerheads
- Manual water regulation with faucet
- Shower arm permanently installed

V-Box Evo

- With six movable showerheads
- Manual water regulation with single-hand faucet
- Height-adjustment of the shower arm manual with pneumatic spring

V-Box Evo 2

- With six movable showerheads
- Electronic water quantity regulation
- Electronic temperature control
- 2-zone shower system for separate sprinkling of the front or back areas
- Electrical height-adjustment of the shower arm

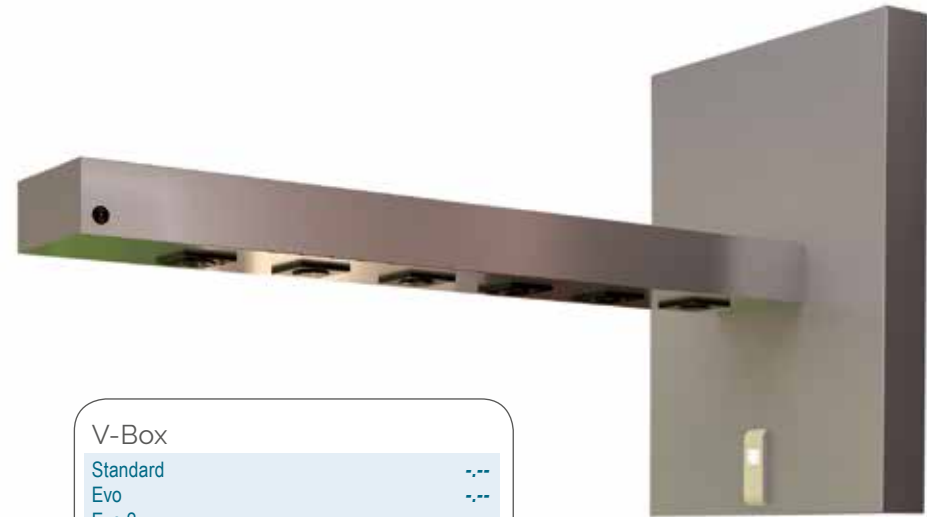

V-Box	
Standard	---
Evo	---
Evo 2	---



Movable showerheads

The six shower heads of the V-Box are movable and can be adjusted by hand in all directions. This allows them to be used in a targeted and selective fashion right when you need them.



30 cm adjustable Height

Adjustable height

On the V-Box Evo, the shower arm can be manually adjusted by up to 30 cm in height by means of a pneumatic spring. Height adjustment on the Evo 2 model is electric.



- Wall plate height: approx. 120 cm
- Wall plate width: approx. 81 cm max.
- Shower arm length: approx. 200 cm

Jet Shower



Jet Shower

The Jet Shower offers stimulating and muscle-relaxing hydro massages. To create a personalized feeling of well-being for your customers, the strength as well as the temperature of the water jet can be regulated at the same time. The Jet Shower is equipped with three water jets that allow treatments with thin, medium, and strong jets. The device is also suitable for the application of hot water, tap water, as well as salt and mineral (corrosive) water.

Features:

- Jet (massage) shower for hydro-massage treatments with warm water in the 36 to 39 °C temperature range
- Water temperature easily set via single-hand faucet
- With three different water nozzles: thin jet for the main treatment/middle jet/high-pressure jet
- Simultaneous regulation of water pressure and temperature possible
- Control display for water pressure and temperature
- Suitable for hot water, tap water, sea water, and corrosive water



Jet Shower

Complete



- Height: 130 cm
- Depth: 55 cm
- Width: 55 cm
- Connections: 3/4"
- Required water pressure: 2.5-3 bar

Spa tables



MLX Limber series



MLX series



MLR series



MO1 series



MLW F1 series



MLW F2



MLW series

MLX Limber series



MLX Limber

With its numerous adjustment options, the MLX Limber enables unique flexibility – for a new dimension in your treatments.

Four different model versions, each available with or without storage space, provide the optimal tool for every need. In the "Flex" top model, the armrests can be lowered at both ends, which makes the table usable on all sides. The oval-shaped table surface and the extremely narrow base allow for better access to the head/neck and leg areas. Up to six actuators allow extreme positions and thus make the Limber a multifunctional table with unmatched flexibility. The optional storage space in the table base allows for the practical storage of work instruments and equipment such as two medium-sized Hot Cabis.

Features:

- Available in four table surface versions
- Depending on the version, height, inclination, head, back, leg, and/or foot section are electrically adjustable
- Up to eight pre-stored positions can be called up at the push of a button
- Lowerable armrests
- Armrests swivel horizontally
- Inclined head section(s) with face cradle
- Trendelenburg feature
- Locking feature
- With PU comfort upholstery in two thicknesses or synthetic leather upholstery
- Standard upholstery color: White. Other colors from our color collections for additional charge
- Base in white or wenge, optional in other decors
- Doors made of Corian®
- Depending on the model with generous storage space in the base, for example for up to two medium-sized Hot Cabis



- Height: approx. 63-100 cm
- Length: approx. 203 cm
- Width: approx. 85 cm max.
- (Recommended) lifting capacity: 300 kg
- Load capacity of the table surface: 350 kg



MLX Limber

- MLX Limber Classic ---
- MLX Limber Pro ---
- MLX Limber Flex ---
- MLX Limber Podo ---

MLX Limber without storage compartment

- MLX Limber Classic ---
- MLX Limber Pro ---
- MLX Limber Flex ---
- MLX Limber Podo ---



MLX Limber with soft upholstery

MLX Limber series



Limber Flex

For ultimate maneuverability, the Limber Flex is equipped with lowerable, swiveling armrests on both the head and foot sides, as well as an inclinable head section with face cradle.

This makes it possible to use this table model from both sides, and completely new treatment positions can be set for a spa table. – Limber Flex: Treatments without limits!



Limber Pro

Thanks to its lowerable armrests and inclinable head section with face cradle, the Limber Pro is also suitable for treatments in prone position. The fold-out foot section

provides relief for the feet. In addition, it also allows foot treatments.

MLX Limber series









Limber Podo

The Limber Podo is extremely versatile. In addition to the complete functions of a high-class spa table, the Podo version offers laterally swiveling and lowerable footrests. These

allow, in addition to classic foot treatments, the use of our matching mobile PediSpa tub. This way your customers are well taken care of!

PediSpa Mobile
 Footspa on castors

Options (more info. after page 20)

	Soft Upholstery	---
	Smart-Thermo: programmable heating system with automatic shut-off	---
	Color upholstery: max. 2 different colors PU, each color	---
	Synthetic leather standard, per color	---
	Synthetic leather Ferrari Stamskin Top, per color	---
	Synthetic leather Ferrari Stamskin One, Macchiato	---
	Metal parts in special colors (white, titanium, or dark brown are included in the table price)	---
	Decor surfaces our collection, (White and wenge are included in the table price)	---
	Foot switch memory function: for controlling the basic functions and the memory positions	---



Limber Classic

This version is equipped with two lowerable armrests, a tiltable head section with face cradle, and a full-length table surface. For classic facial and spa treatment.

Accessories (see also page 154)

Back/arm upholstery for Limber Podo	---
Dentalax neck rest, synthetic leather	---
Dentalax neck rest, PU	---
Gel cushions for the face cradle	---
Terrycloth (white, macchiato, or choco)	---
Foot protective cover, PVC, transparent	---
PU protective cover, Art. 49051	---

MLX



MLX

Our exclusive designer table for spa and wellness. Despite the customer-friendly low step height of 57 cm, the table base offers practical storage space. The removable armrests and covers, for example, and other table accessories can be stowed within reach here.

Four actuators allow for optimal adjustment options, of which up to eight can be stored as memory positions. Removable armrests and fold-down frame in the head area make the MLX a perfect work tool for professionals. For individual requests, the features of the MLX as well as its "look" can also be customized.

Features:

- Large storage space
- Two removable arm pads
- Face cradle
- Four actuators for electrical adjustment of height, back, leg, and foot sections
- Trendelenburg feature
- Eight treatment positions can be saved
- Locking feature
- Soft, robust PU upholstery
- Also available in synthetic leather
- Optional: Soft upholstery
- Standard upholstery color: White. Other colors from our color collection for an additional charge
- Base in white or wenge, optional in other decors
- Full-length large drawer or two small drawers and a folding compartment
- Frame in the head area folds down, for a better accessibility of face and décolleté



MLX

4-actuator



- Height: approx. 58-98 cm
- Length: 203 cm
- Width: 80 cm
- (Recommended) lifting capacity: 300 kg
- Load capacity of the table surface: 350 kg

MLX



Exclusive, practical, & comfortable

This exclusively-designed spa table can be optimally adjusted electrically via four actuators. Thus, not only is a customer-friendly step height of 57 cm possible, but also the adjustability of the backrest by approx. 70°, the leg area by about 23°, and the inclination angle of the table surface by

about +/- 15°. Eight storable memory positions also allow the Wellmassage4D, which is specially-designed for the MLX. Thus, customers experience an innovative, extraordinary massage experience and therapists are able to work effortlessly and in a back-friendly fashion.



Trendelenburg feature

In this zero-gravity table position, the head section is particularly low and the foot section is raised. This allows customers to relax very deeply.



Two storage space versions

On request, the table base can be equipped with a three-part drawer or a combination of two drawers and a larger fold-out compartment.



Removable armrest upholstery



Simply remove the upholstery of the armrests at the height of the head section and fold the frame down – your customer will then be able to lay down their arms comfortably during all prone treatments.



Available as a Wellmassage4D special edition

With eight pre-set table positions and special treatment steps, high tech & high touch come together to form a treatment for exceptional deep relaxation (page 40).

Options (more info. after page 20)

-  Soft Upholstery ---
-  Smart-Thermo: programmable heating system with automatic shut-off ---
-  Color upholstery: max. 2 different colors PU, each color ---
-  Multimedia sound system Audio-Relax-Headrest ---
-  Metal parts in special colors (white, titanium, or dark brown are included in the table price) ---
-  Decor surfaces: our collection, (White and wenge are included in the table price) ---
-  Foot switch memory function: for controlling the basic functions and the memory positions ---
-  IR Handheld remote control: wireless operation for controlling the table ---
-  Spa Ambience Light: Base with LED lighting ---

Accessories (see also page 154)

- Dentalax neck rest, synthetic leather ---
- Dentalax neck rest, PU ---
- Gel cushions for the face cradle ---
- Terrycloth (white, macchiato, or choco) ---
- Foot protective cover, PVC, transparent ---
- PU protective cover, Art. 49051 ---

Velaa Private Island Maldives





Photos: ©Velaa Private Island

MLR Classic



MLR Classic

The purist MLR Classic has – like the MLX designer bed – two strong lifting columns, which permit a wide range of reclining positions. The absence of storage space in the lower area ensures optimal legroom during treatment.

Height, inclination, as well as back and foot sections are electrically adjustable. In addition, the MLR is equipped with a Trendelenburg feature and a locking feature; and of course there is also a face cradle in the rest.

As an additional option, the Smart-Thermo offers a programmable heating system with automatic switch-off as well as a foot switch for controlling the basic functions.

Features:

- Face cradle
- Height, inclination, as well as back and foot areas are electrically adjustable.
- Base made from wood decor
- Metal edge protection at the base
- Trendelenburg feature
- Locking feature
- Robust synthetic leather upholstery
- Optional PU and soft upholstery
- Standard upholstery color: White. Other colors from our color collection for an additional charge
- Base in white or wenge, optional in other decors



- Height: 57-87 cm
- Length: 203 cm
- Width: 80 cm
- (Recommended) lifting capacity: 300 kg
- Load capacity of the table surface: 350 kg

MLR

4-actuator



MLR Classic



Clear design, high degree of functionality

The MLR Classic can be optimally adjusted electrically via four actuators. Thus, not only is a low step height of 57 cm possible, but also the adjustability of the backrest by ap-

prox. 70°, the leg area by around 25°, and the inclination angle of the table surface by about +/- 15°. The four-part table surface can thus adapt to almost all treatment requirements.



Edge protection on the base

The high-end edge protection on both ends of the table base prevents unsightly wear and damage to the decor. This keeps the MLR always looking well-maintained.



Trendelenburg position

Customers will find particularly pleasant relaxation in the zero gravity bed position with lowered head and raised feet.



Extreme legroom







The MLR offers maximum legroom for all treatments thanks to the particularly slim and elegantly designed lifting columns and the absence of storage space in the bed base.



Also as a wet table version

With a water-resistant PU cover and water-resistant base, the MLR is also perfect for all wet and outdoor treatments (see page 82 for details).

Options (more info. after page 20)

-  Soft Upholstery -.-
-  Smart-Thermo: programmable heating system with automatic shut-off -.-
-  Color upholstery: max. 2 different colors
 - PU, each color -.-
 - Synthetic leather standard, per color -.-
 - Synthetic leather Ferrari Stamskin Top, per color -.-
 - Synthetic leather Ferrari Stamskin One, Macchiato -.-
-  Metal parts in special colors (white, titanium, or dark brown are included in the table price) -.-
-  Decor surfaces our collection, (White and wenge are included in the table price) -.-
-  Foot switch to control the basic functions -.-

Accessories (see also page 154)

- Dentalax neck rest, synthetic leather -.-
- Dentalax neck rest, PU -.-
- Gel cushions for the face cradle -.-
- Terrycloth (white, macchiato, or choco) -.-
- Foot protective cover, PVC, transparent -.-
- PU protective cover, Art. 49051 -.-

Corendon City Hotel Amsterdam

The Netherlands





MLR Select series



MLR Select

You own personal spa table. Our new MLR Select follows this principle with its three different basic versions, "Alu," "Wood," and "Static," each with three upholstery widths. Storage space was intentionally omitted here to ensure optimum legroom. With its reduced design, this table does not need to hide behind its "big sister," the MLX. Two powerful lifting columns, lowering and swiveling armrests, adjustable head, back, leg and foot sections, and an optional fold-out foot section make the MLR Select a versatile work tool. In addition, the table is equipped with a Trendelenburg feature and a locking feature.

As an additional option, the Smart-Thermo offers a programmable heating system with automatic switch-off as well as a foot switch for controlling the basic and memory functions.

Features:

- Three basic versions with wood or aluminum trim or for direct floor mounting
- Height, inclination, as well as back and foot areas are electrically adjustable.
- Swiveling and lowering armrests
- also available in a pro version with fold-out foot section
- Trendelenburg feature
- Robust PU upholstery in three widths
- Face cradle
- Optional soft upholstery
- Standard upholstery color: White. Other colors from our color collection for an additional charge
- Hand switch with locking feature (Design hand switch on Select Alu)
- Optional: Hand switch with memory feature for up to eight table positions (included with Select Alu)



- Height: 61-97 cm
- Length: 200 cm
- Width: S 76 cm / M 85 cm / L 92 cm
- (Recommended) lifting capacity: 300 kg
- Load capacity of the table surface: 350 kg

MLR Select Alu

Small (upholstery width: 76 cm)	---
Small (upholstery width: 85 cm)	---
Large (upholstery width: 92 cm)	---

Fold-out foot section, manual	---
Fold-out foot section, electrical	---



MLR Select Alu including Alu Design hand switch



MLR Select Wood

Small (upholstery width: 76 cm)	---
Small (upholstery width: 85 cm)	---
Large (upholstery width: 92 cm)	---

Fold-out foot section, manual	---
Fold-out foot section, electrical	---



MLR Select Static

Small (upholstery width: 76 cm)	---
Small (upholstery width: 85 cm)	---
Large (upholstery width: 92 cm)	---

Fold-out foot section, manual	---
Fold-out foot section, electrical	---

MLR Select series



MLR Select Vintage

The unique MLR version with storage space in a retro design is an absolute highlight. The base with exclusive metal-wood look offers extensive storage space for towels and everything else you need for your work.

Like the other members of the MLR Select family, the Vintage has two strong lift columns, lowering and swiveling armrests, adjustable head, back, leg, and foot sections, and an optional fold-down foot section. In addition, the table is equipped with a Trendelenburg feature and a locking feature.

As an additional option, the Smart-Thermo offers a programmable heating system with automatic switch-off as well as a foot switch for controlling the basic and memory functions.

Features:

- Base with vintage design in metal-wood look (standard monochrome decor)
- Multicolor design possible
- With side panels
- Height, inclination, as well as back and foot areas are electrically adjustable.
- Swiveling and lowering armrests
- also available in a pro version with fold-out foot section
- Trendelenburg feature
- Robust PU upholstery in three widths
- Face cradle
- Optional soft upholstery
- Standard upholstery color: White. Other colors from our color collection for an additional charge
- Hand switch with locking feature
- Optional: Hand switch with memory feature for up to eight table positions



- Height: 61-97 cm
- Length: 200 cm
- Width: S 76 cm / M 85 cm / L 92 cm
- (Recommended) lifting capacity: 300 kg
- Load capacity of the table surface: 350 kg

MLR Select Vintage

Small (upholstery width: 76 cm)	---
Small (upholstery width: 85 cm)	---
Large (upholstery width: 92 cm)	---

Fold-out foot section, manual	---
Fold-out foot section, electrical	---



Vintage Trolley

Matching the design of the MLR Select Vintage, the Vintage Trolley with its three drawers and two shelves offers plenty of space for your work instruments.

With its brakable lightweight wheels, it can be positioned wherever you need it.

Vintage Trolley

Monochrome	---
------------	-----

MLR Select series

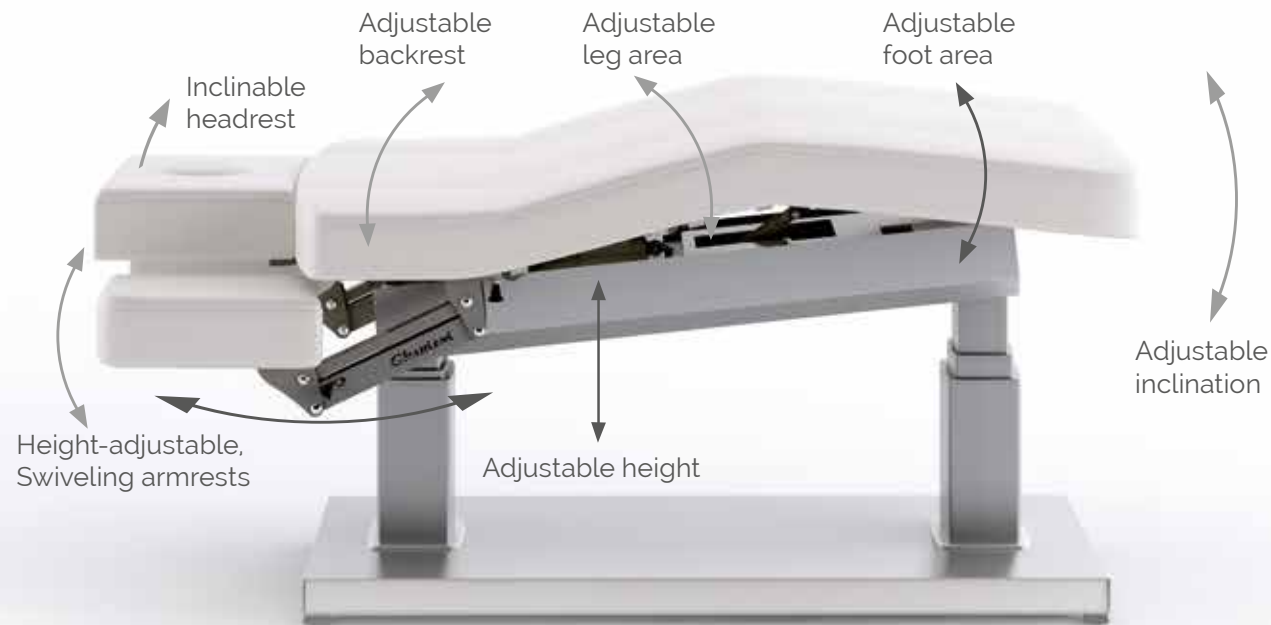

Practical & Versatile

Do not be fooled by the simplified design of our MLR Select! In terms of adjustability, versatility, and ergonomics, it also meets the highest demands. The head section can be tilted by +/- 30°. With two lifting columns, the height of 57-97 cm

can be adjusted electrically, the back and leg sections can be adjusted by 70° or 30°, and the armrests can be lowered by approx. 15 cm. The inclination of the table surface can be adjusted by +/- 15°.



Fold-out foot section

The optionally available fold-out foot section not only facilitates treatment of the feet; but also allows their relaxed, natural position with massages in the prone position.



Trendelenburg position

Customers will find particularly deeper relaxation in the zero gravity bed position with lowered head and raised feet.

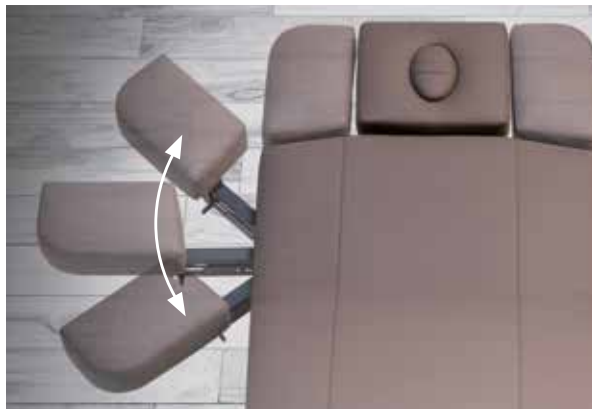

Swiveling armrests







The swiveling armrests give your treatments the necessary freedom: Simply swivel them backwards and you're able to "freely" work on the head, neck, and décolleté area. The pads can be locked in four positions.



High-end application

The side surfaces of the foot of the MLR Select Alu come standard with synthetic leather, which matches that of the table upholstery. Optionally, however, it is also possible to choose an elegant wood decor.

Options (more info. after page 20)

-  Soft Upholstery ---
-  Smart-Thermo: programmable heating system with automatic shut-off ---
-  Color upholstery: max. 2 different colors PU, each color ---
-  Metal parts in special colors (white, titanium, or dark brown are included in the table price) ---
-  Decor surfaces: our collection, (White and wenge are included in the table price) ---
-  Hand switch with memory function: up to four table positions can be stored (included in the price of MLR Select Alu) ---
-  Foot switch memory function: for controlling the basic functions and the memory positions ---

Accessories (see also page 154)

- Dentalax neck rest, synthetic leather ---
- Dentalax neck rest, PU ---
- Gel cushions for the face cradle ---
- Terrycloth (white, macchiato, or choco) ---
- Foot protective cover, PVC, transparent ---
- PU protective cover, Art. 49051 ---



SIX SENSES SPA

Puente Romano
Marbella, Spain



Photos: © Puente Romano, Marbella

MO1 series



MO1 Evo

Our MO1 Evo has an extremely low access height from 50 cm. This table allows even very short or physically restricted customers comfortable and convenient access. The armrests can be electrically lowered and swiveled on request (exception: the MO1 with removable headrest). The optional storage space in the base is flexible and configurable. This way, Hot/Cool Cabis can be integrated on the head and/or foot side. Three table surface versions ensure individual adaptability.

Whether it's standard/soft upholstery or full-length table surface with attachable headrest (without armrests) – simply choose the table that best suits your needs! Optionally, the MO1 can even be equipped with chest relief upholstery. This ensures that for women, the chest area is relieved in the prone position.

Of course, all models can also be individually configured for upholstery color and basic decor. Ask for our current color and decor patterns!

Features:

- Extremely low access height of 50 cm and therefore well suited for people with physical disabilities
- Up to six actuators for adjusting the height, back, leg, and foot sections and optionally for the armrests as well
- Swiveling armrests (not on the MO1 with removable headrest)
- Eight treatment positions can be saved
- Hand switch with locking feature
- Quilted PU upholstery in three widths
- Three available upholstery versions
- Optional storage space in the base (open or closed)
- Mechanical (optionally electrical) extendable castors
- Standard upholstery color: White. Other colors from our color collection for an additional charge
- Base in white or wenge, optional in other decors
- Optional LED lighting strip for base lighting
- Bracket for attaching a (magnifying) lamp optional
- Optional with scent diffuser



- Height: 50-82 cm
- Length: 205 cm
- Width: S 76 cm / M 85 cm / L 92 cm
- (Recommended) lifting capacity: 250 kg
- Load capacity of the table surface: 300 kg



MO1 Evo with standard upholstery

MO1 Evo

Small (upholstery width: 76 cm)	---
Small (upholstery width: 85 cm)	---
Large (upholstery width: 92 cm)	---

Integrated storage space	---
(Magnifying) lamp holder on both sides	---
Chest relief upholstery	---



MO1 Evo with soft upholstery



MO1 EVO with removable headrest (without armrests!)

Small (upholstery width: 76 cm)	---
Small (upholstery width: 85 cm)	---
Large (upholstery width: 92 cm)	---

M01 series



MO1 Square

Like the MO1 Evo, the 50-inch MO1 Square also offers extremely low access and exit height for very short or physically restricted people.

With up to six actuators, the MO1 Square enables the perfect fit for your treatments. Thus, not only the height of the bed, back, leg, and foot sections can be positioned automatically, but optionally also the armrests. In addition, eight storable treatment positions ensure particularly practical work.

For an exceptional spa experience for your customers, the MO1 Square can also be equipped with numerous extras. But in terms of looks, the table also fulfills all wishes: 3D milling patterns in numerous decors give "your" MO1 Square an individual touch, matching your ambience!

Features:

- Extremely low access height of 50 cm and therefore well suited for people with physical disabilities
- Up to six actuators for adjusting the height, back, leg, and foot sections and optionally for armrests as well
- Swiveling armrests
- Eight treatment positions can be saved
- Locking feature
- Particularly heavy-duty
- Quilted PU upholstery in three widths
- Also available with soft upholstery
- Standard upholstery color: White. Other colors from our color collection for an additional charge
- Flexible storage space in the base (open or closed)
- Electrically extendable castors
- Base in white or wenge, optional in other decors
- Optional LED lighting strip for base lighting
- Bracket for attaching a (magnifying) lamp optional
- Optional with scent diffuser



- Height: 50-82 cm
- Length: 205 cm
- Width: S 76 cm / M 85 cm / L 92 cm
- (Recommended) lifting capacity: 250 kg
- Load capacity of the table surface: 300 kg



MO1 Square with standard upholstery



MO1 Square with soft upholstery

MO1 Square

Small (upholstery width: 76 cm)	---
Small (upholstery width: 85 cm)	---
Large (upholstery width: 92 cm)	---

Chest relief upholstery	---
(Magnifying) lamp holder on both sides	---



MO1 series



Extremely low access height

With a height adjustability of 50-82 cm, the MO1 Evo and MO1 Square are the ideal table models, even for short or physically restricted customers; because the minimum height of 50 cm makes it easier to get in and out of the table. In addition, the MO1 offers optimal adjustability. Thus, the head section can be tilted by +60°/-35° and the armrests can

optionally be electrically lowered at the push of a button. The backrest can be set up to 70° and the leg section up to 20°. And for "your" perfect table model, configure the MO1 with a soft, super-soft upholstery, or a full-length upholstery with a clip-on headrest.





Integrated Hot/Cool Cabi

Integrated compartments in the MO1 Evo on the head and/or foot side of the table base allow Hot and Cool Cabis to be stored. It's a great way to work and your workspace will always be tidy.

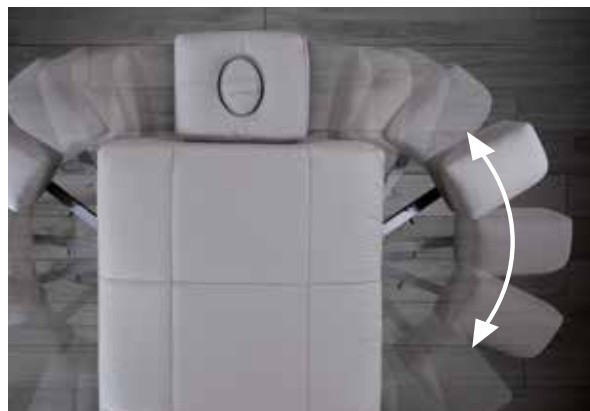

Swiveling armrests

If you need a lot of space for the facial, you don't necessarily have to go without armrests. The swiveling armrests give you the necessary free space. Simply swivel them backwards and you're ready to "freely" work on the head, neck, or décolleté area.



Optional: Holder for (magnifying) lamps















The extendable (magnifying) lamp holder made of stainless steel is completely new. When not in use, it simply disappears under the table – a feature no other manufacturer offers. The matching Flex LED magnifying lamp allows for precision while working.



Optional: Aroma therapy

Wellness with all the senses: Immerse your customers into a world of soothing scents during treatment. Your treatment will be a fragrant experience thanks to the integrated scent diffuser.

Options (more info. after page 20)

-  Soft Upholstery ...
-  Electrical lowerable armrests ...
-  Triple-Airback® technology: electro-pneumatic 3-zone lordosis support system of the upholstery ...
-  Smart-Thermo: programmable heating system with automatic shut-off ...
-  Vibro-Wellness: gently pulsating vibration system with many adjustment options ...
-  Color upholstery: max. 2 different colors PU, each color ...
-  Multimedia sound system
Audio-Relax-Headrest ...
-  Metal parts in special colors (white, titanium, or dark brown are included in the table price) ...
-  Decor surfaces our collection, (White and wenge are included in the table price) ...
-  Electrically lowerable castors (included in the table price on the MO1 Square) ...
-  Foot switch memory function: for controlling the basic functions and the memory positions ...
-  IR Handheld remote control: wireless operation for controlling the table ...
-  Spa Ambience Light: Base with white LED lighting ...
-  Aroma therapy ...

Accessories (see also page 154)

- (Magnifying) lamp holder on both sides ...
- "Flex" LED magnifying lamp ...
- Dentalax neck rest, synthetic leather ...
- Dentalax neck rest, PU ...
- Terrycloth (white, macchiato, or choco) ...



Hotel Barriere Les Neiges
Courchevel, France



Photos: © Fabrice Rambert // MARCBERENQUER.COM

MLW F1 series



MLW F1

The spa table with a special design! The advancement of the MLW Classic has a narrow base, is just 57 cm wide, and features specially curved front ends. These features allow more foot and legroom, making it easier to work on massages and cosmetic treatments. The comfortable full-length upholstery is available in two thicknesses, offering exceptional comfort for every need – even for longer treatment sessions.

A particular highlight is that the wood side panels can be replaced with new ones if necessary. This way you can always adapt the table to your personal ambience.

Features:

- Narrow base trim and gently curved front ends for more legroom
- Configurable equipment
- Exchangeable side wood decor casing
- Up to six actuators for adjusting the height, back, leg, and foot sections and optionally for the armrests as well
- Up to eight treatment positions can be saved
- Control selectable from wired hand switch, footswitch, or infrared remote control
- Lowerable and swiveling armrests
- Head section +/- 30° tiltable
- Full-length molded PU upholstery with memory foam in three widths
- Standard upholstery color: White. Other colors from our color collection for an additional charge
- Base in white or wenge, optional in other decors
- Mechanically lowerable castors

MLW F1

Small (upholstery width: 76 cm)	---
Small (upholstery width: 85 cm)	---
Large (upholstery width: 92 cm)	---



MLW F1 with standard upholstery



MLW F1 with soft upholstery



- Height: 58-91 cm
- Length: 203 cm
- Width: S 76 cm / M 85 cm / L 92 cm
- (Recommended) lifting capacity: 250 kg
- Load capacity of the table surface: 300 kg

MLW F1 series



More comfort with six actuators

Our size M and L MLW F1 models are now also available with six actuators. For more comfort, the armrests – in addition to height, back, leg, and foot area adjustment – can also be controlled synchronously. In addition to direct settings via pushbuttons on the armrests themselves, their setting can be conveniently saved using the memory functions. This al-

lows the F1 to be moved to the programmed positions with a single push of a button. The table surface can be adjusted from 58-91 cm in height, the backrest by about 70°, the leg area by about 25°, and the foot by up to 18°. The head section can be tilted by +/- 30°.





Swiveling armrests

If you need a lot of space for the facial, you don't necessarily have to go without armrests. The swiveling armrests give you the necessary free space. Simply swivel them backwards and you're able to "freely" work on the head, neck, and in the décolleté area.

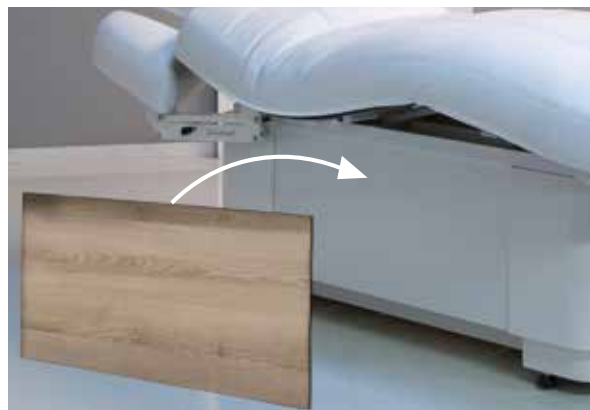

Exchangeable wood trim

Looking for a new design? Why not just swap out the entire table? The side trim on our MLW F1 Wood can be very easily exchanged. Our numerous decors offer something for every ambience and a new, fresh look!



Specially formed front ends











The curved shape of the front ends made of aluminum provide you with enough legroom for all kinds of treatments. This way you can work in comfortably and enjoyably. The parts are available in different anodized colors.



Spa Ambience Light

The concealed LED strip on the table base adds a light accent in your desired color to the MLW F1 and ensures atmospheric lighting in your workspace.

Options (more info. after page 20)

-  Soft Upholstery ---
-  Electrical lowerable armrests ---
-  Triple-Airback technology: electro-pneumatic 3-zone lordosis support system of the upholstery ---
-  Smart-Thermo: programmable heating system with automatic shut-off ---
-  Vibro-Wellness: gently pulsating vibration system with many adjustment options ---
-  Color upholstery PU: max. 2 colors possible, each color ---
-  Multimedia sound system Audio-Relax-Headrest ---
-  Metal parts in special colors (white, titanium, or dark brown are included in the table price) ---
-  Decor surfaces: our collection, (White and wenge are included in the table price) ---
-  Foot switch memory function: for controlling the basic functions and the memory positions ---
-  IR Handheld remote control: wireless operation for controlling the table ---
-  Spa Ambience Light: Base with LED lighting ---

Accessories (see also page 154)

- Dentalax neck rest, PU ---
- Gel cushions for the face cradle ---
- Terrycloth (white, macchiato, or choco) ---
- Foot protective cover, PVC, transparent ---
- PU protective cover, Art. 49051 ---

Jean d'Arcel Cosmétique Training center Kehl, Germany





MLW F2



MLW F2

The elegantly designed MLW F2 spa table offers perfect lying and working alike. The particularly narrow table base allows for optimum legroom during treatment. In addition, the tilting head section, the lowerable armrests, and the adjustable footrest can be extended. Thus, the F2 can be easily adjusted to every customer and every treatment.

Eight storable treatment positions and control via wired hand switch, footswitch, or infrared remote control also make everyday work easier. The pleasantly soft PU upholstery is available in Small, Medium, and Large. This way you can even offer the "heavyweights" among your customers optimal lying comfort.

And that little extra: Optionally, the MLW F2 can be equipped with a flat screen integrated into the table base on both sides or with an LED-illuminated, semi-transparent glass surface. This ensures that your workspace will have your own extraordinary, personalized ambience with atmospheric films, slideshows, still images, or a changing play of colors.

Features:

- Narrow base trim for more legroom
- Configurable equipment
- Pull-out head and foot section and armrests
- Height, back, leg, and foot section electrically adjustable
- Lowerable armrests
- Head section +/- 30° tiltable
- Up to eight treatment positions can be saved
- Control selectable from wired hand switch, footswitch, or infrared remote control
- Soft PU upholstery in three widths
- Standard upholstery color: White. Other colors from our color collection for an additional charge
- Base in white or wenge, optional in other decors
- Mechanically lowerable castors



- Height: 58-91 cm
- Length: 199 cm
- Width: S 76 cm / M 85 cm / L 92 cm
- (Recommended) lifting capacity: 250 kg
- Load capacity of the table surface: 300 kg

MLW F2

Small (upholstery width: 76 cm)	---
Small (upholstery width: 85 cm)	---
Large (upholstery width: 92 cm)	---



MLW F2

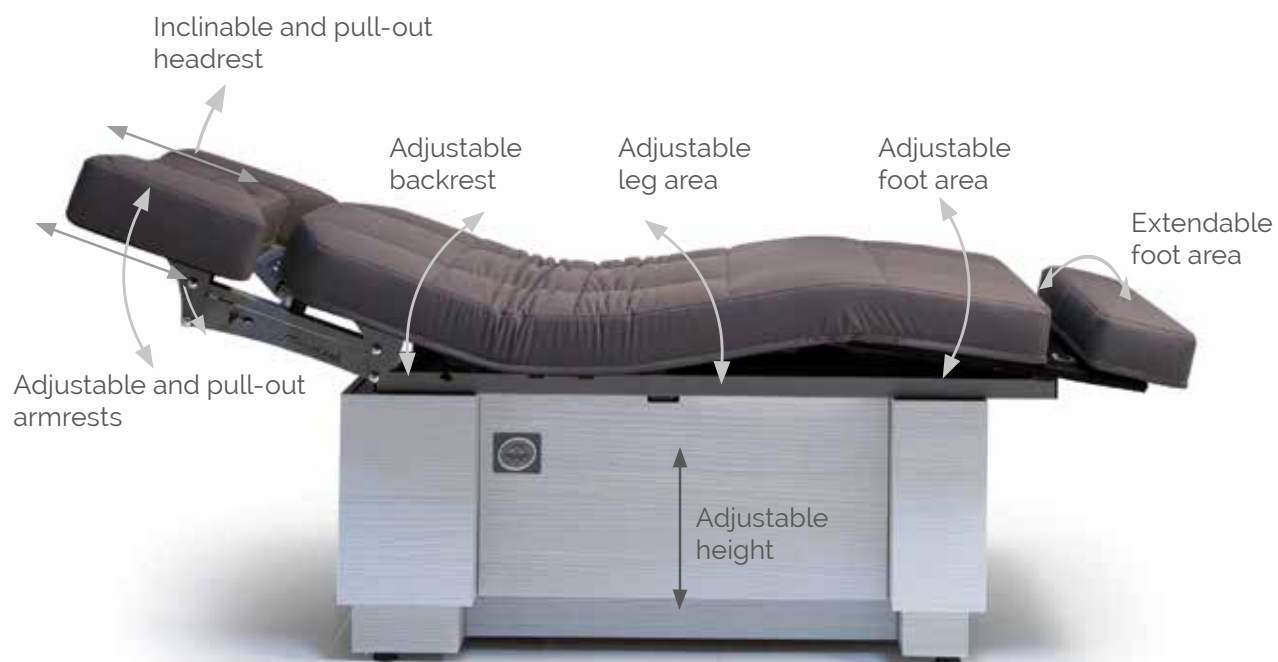

Perfectly adjustable

The entire MLW F2 line with its height of 58-91 cm is a stunner: Its extra-narrow table base allows for optimum legroom and its maximum adjustability makes it perfect for all treatments and every customer. For example, the head section can be tilted by $+60^{\circ}/-30^{\circ}$ and extended by about 7 cm. The

armrests can be lowered and extended by 8 cm. The adjustable foot section can be extended by 7 cm. The adjustable back and leg area in combination with the pleasantly soft PU upholstery, which is available in Small, Medium, and Large, also ensure optimum lying comfort.





Flexible foot section

For particularly tall customers, the foot section can be extended by means of a snap-in position. For better accessibility of the feet, the foot pad can also be completely removed.



Adjustable

With the head section extendable by seven centimeters and pull-out armrests, the table can also be easy and quickly adapted to taller customers.



Color play











The color play of the built-in LED system bathes the base in gentle, changing colors – just the right rainbow feeling to relax. Price and delivery times upon request.



Integrated flat screen

Whether with atmospheric films, slideshows, or still images to match your treatments – with the integrated flat screen, the MLW F2 becomes an eyecatcher in your workspace. Price and delivery times upon request.

Options (more info. after page 20)

-  Soft Upholstery ...
-  Triple-Airback technology: electro-pneumatic 3-zone lordosis support system of the upholstery ...
-  Smart-Thermo: programmable heating system with automatic shut-off ...
-  Vibro-Wellness: gently pulsating vibration system with many adjustment options ...
-  Color upholstery PU: max. 2 colors possible, each color ...
-  Audio-Relax-Headrest ...
-  Metal parts in special colors (white, titanium, or dark brown are included in the table price) ...
-  Decor surfaces our collection, (White and wenge are included in the table price) ...
-  Foot switch memory function: for controlling the basic functions and the memory positions ...
-  IR Handheld remote control: wireless operation for controlling the table ...
-  Spa Ambience Light: Base with LED lighting ...

Accessories (see also page 154)

- Dentalax neck rest, PU ...
- Gel cushions for the face cradle ...
- Terrycloth (white, macchiato, or choco) ...
- Foot protective cover, PVC, transparent ...
- PU protective cover, Art. 49051 ...

Hotel Plunhof South Tyrol, Italy





MLW series



MLW Classic

Variable and individual: From the upholstery to the casing, many elements can be individually selected with this classic spa table.

The low height of about 57 cm facilitates access and the maximum height of 92 cm allows back-friendly working. Table area widths in Small (76 cm), Medium (85 cm), and Large (92 cm) are available. In addition to the standard version, there is a soft PU upholstery available as well, offering exceptional comfort to meet every need – even during longer treatment sessions.

Equipped with up to four actuators, treatment positions as well as four freely storable memory positions can be set for this table. The armrests are lowered by pneumatic springs.

Features:

- Table surface in three widths (S, M, and L)
- Height, back, leg, and foot section electrically adjustable
- Four storable positions
- Lowerable armrests
- Head section +/- 30° tiltable
- Soft PU upholstery as standard and soft version
- Standard upholstery color: White. Other colors from our color collection for an additional charge
- Base in white or wenge, optional in other decors
- Mechanically extendable castors



- Height: 57-92 cm (for standard upholstery)
- Length: 203 cm
- Width: S 76 cm / M 85 cm / L 92 cm
- (Recommended) lifting capacity: 250 kg
- Load capacity of the table surface: 300 kg



MLW with standard upholstery

MLW Classic

- | | |
|---------------------------------|-----|
| Small (upholstery width: 76 cm) | --- |
| Small (upholstery width: 85 cm) | --- |
| Large (upholstery width: 92 cm) | --- |



MLW with soft upholstery



MLW series



MLW Amphibia

Whether for classic facial and whole-body treatments "on land" or relaxing spa applications "on water," the MLW Amphibia combines both: The Aqua upholstery, as well as the firm padding, allow for a very flexible variety of treatments, even those currently in vogue.

The four actuators allow for a variety of height, back, thigh, and leg section adjustments. The access height is 54 cm. Four treatment positions can conveniently be stored and retrieved as required via the memory function. The head section can be tilted up and down by 30° each with a pneumatic spring and the armrests are also continuously lowerable and therefore ideal for back treatments!

Features:

- Table surface with heated Aqua upholstery
- Height, inclination, as well as backrest and foot section electrically adjustable.
- Lowerable armrests
- Head section +/- 30° tiltable
- Four treatment positions can be saved
- Illuminated table surface and sides
- Soft PU upholstery can be exchanged for Aqua upholstery
- Triple-Airback technology: electro-pneumatic 3-zone lordosis support system of the upholstery
- Inflation connection for optional Ayurveda cover
- Base in white or wenge, optional in other decors
- Mechanically lowerable castors



- Height: 54-90 cm
- Length: 202 cm
- Base width: 55 cm
- Table surface width: 85 cm
- (Recommended) lifting capacity: 250 kg
- Load capacity: approx. 300 kg



MLW Amphibia

Including water cushion



MLW series



Perfect for any treatment

With four actuators, a height of 54-96 cm can be electrically adjusted on the MLW series table models. The backrest can also be adjusted electrically by approx. 70°, the leg area by approx. 25°, and the foot section by up to 18°. The armrests

can be lowered by up to 15 cm using a pneumatic spring and the head section can be tilted by +/- 30°. The four storable treatment positions are also quite practical at work.





Comfortable soft upholstery

The extra-soft soft upholstery version of the MLW Classic will leave your customers floating on air. Made of skin-friendly, hygienic PU, the table upholstery is particularly suitable for long treatments.



Optimally regulated warmth

The Smart-Thermo table heater has a temperature control with an automatic shut-off. This way you can ensure an optimal table upholstery temperature.



Side shelves

On request, the table can be equipped with two shelves running along the side area. There's plenty of space for everything you need during your treatments.



Folding tray with magnetic closure

The practical folding tray at the head of the MLW allows e.g. a tablet with relaxing pictures or films to be placed there that make the view through the face cradle more comfortable for your customers.

Options (more info. after page 20)

- ↑
↓
 Soft Upholstery (not possible on MLW Amphibia) -.-
- ⦿
 Triple-Airback technology: electro-pneumatic 3-zone lordosis support system of the upholstery (included with MLW Amphibia) -.-
- 🌡️
 Smart-Thermo: programmable heating system with automatic shut-off (included with MLW Amphibia) -.-
- 🌊
 Vibro-Wellness: gently pulsating vibration system with many adjustment options -.-
- 🎨
 Color upholstery: max. 2 different colors PU, each color -.-
- 🖌️
 Only with MLW Soft:
 Synthetic leather standard, per color -.-
 Synthetic leather Ferrari Stamskin Top, per color -.-
 Synthetic leather Ferrari Stamskin One, Macchiato -.-
- 🎵
 Audio-Relax-Headrest: with integrated speakers to connect to common players -.-
- 🔩
 Metal parts in special colors (white, titanium, or dark brown are included in the table price) -.-
- 📺
 Decor surfaces our collection, (White and wenge are included in the table price) -.-
- 👣
 Foot switch to control the basic functions -.-

Accessories (see also page 154)

- Dentalax neck rest, synthetic leather -.-
- Dentalax neck rest, PU -.-
- Gel cushions for the face cradle -.-
- Terrycloth (white, macchiato, or choco) -.-
- Foot protective cover, PVC, transparent -.-
- PU protective cover, Art. 49051 -.-

Sparkling Jewel

The high-end trim with quilted upholstery and sparkling Swarovski Elements adds sparkling elegance to your workspace or spa, making the MLW Amphibia a real eye-catcher. And that little extra: The perfectly integrated LED strips not only immerse the water cushions in wonderful and – depending on the setting – changing color light, but the base of the lounger as well. This gives the Swarovski Elements a really impressive sparkle. On request, the quilted base is also available without Swarovski Elements.



Quilted upholstery	
With Swarovski Elements	--
Without Swarovski Elements	--

MLE

The MLE is an absolute all-rounder, because it is suitable for cosmetics, wellness, and massage alike. With four actuators, the height as well as the back and leg sections can be adjusted electrically. The head section can be inclined via a pneumatic spring by +/- 30°. To relieve the shoulder and neck area during massages, the armrests can be lowered electrically.

Features:

- Height, back, and leg section adjustment via three actuators
- Head section +/- 30° tiltable
- Adjusting the head area via pneumatic spring
- Upholstery thickness: 10 cm
- Available in wenge with black-brown corners and choco-colored upholstery
- Including mechanically lowerable castors



MLE

4 actuators

Options (more info. after page 20)



Smart-Thermo: programmable heating system with automatic shut-off

Accessories

Dentalax neck rest, PU

Gel cushions for the face cradle

Terrycloth cover

Foot protective cover, PVC, transparent

PU protective cover, Art. 49051



- Height: 56-90 cm
- Length: 204 cm
- Width: 84 cm
- (Recommended) lifting capacity: 250 kg
- Load capacity of the table surface: 300 kg

Four Seasons Resort Seychelles at Desroches Island Seychelles

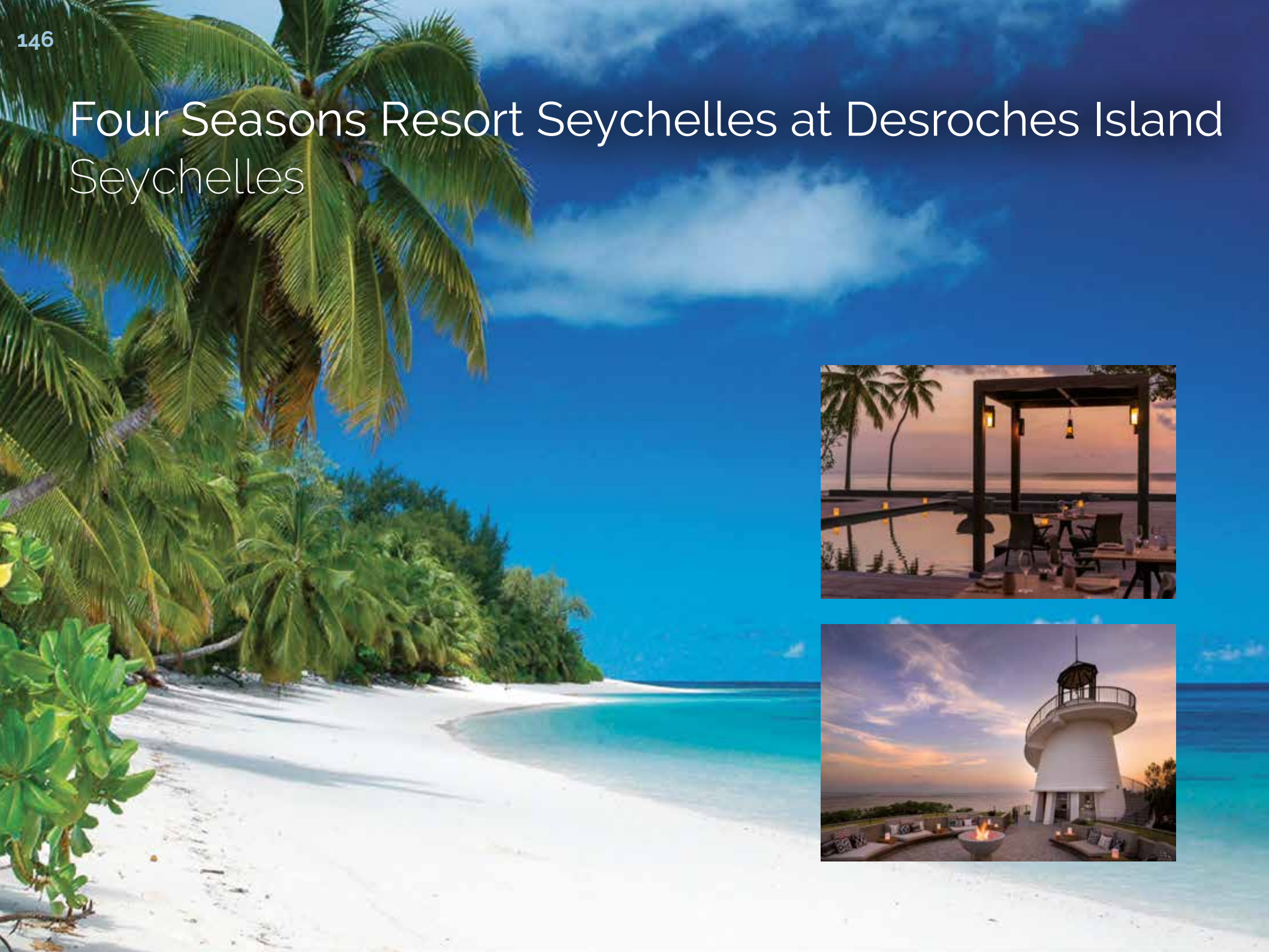



Photos: © Four Seasons

MLW Square



MLW Square

The MLW Square is extraordinary and sophisticated. A special manufacturing process makes the individual design of wood milling in 3D possible, such as the Circle or Rainbow patterns. But it's not just the 3D look that you can decide on according to your taste: by choosing the surface material and color you become a designer yourself. Because there are numerous stylish wood decors as well as paint and high-gloss surfaces available.

In addition, the table features other excellent details. For example, the robust, divided upholstery with the reliable synthetic leather from Skai® or Ferrari offer the highest degree of comfort for any treatment. The upholstery is also available in a full-length PU version, with your choice of white, creme, and choco.

Featuring up to four actuators and numerous optional extras, the MLW Square is the perfect table for doing perfect work!

Features:

- Spa table with 3D casing
- Table surface in three widths (S, M, and L)
- Height, back, leg, and foot section electrically adjustable
- Four treatment positions can be saved
- Head section inclinable +/- 30° via pneumatic spring
- PU upholstery (full-length) or synthetic leather upholstery (divided) selectable
- Standard upholstery color: White. Other colors from our color collection for an additional charge
- Base in white or wenge, optional in other decors
- Mechanically extendable castors
- Optionally with lowerable armrests



- Height: 57-92 cm
- Length: 205 cm
- Width: S 76 cm/M 85 cm/L 92 cm
- (Recommended) lifting capacity: 250 kg
- Load capacity of the table surface: 300 kg



MLW Square (without armrests)

Small (upholstery width: 76 cm)	---
Small (upholstery width: 85 cm)	---
Large (upholstery width: 92 cm)	---
Armrest pair	---

MLW Square

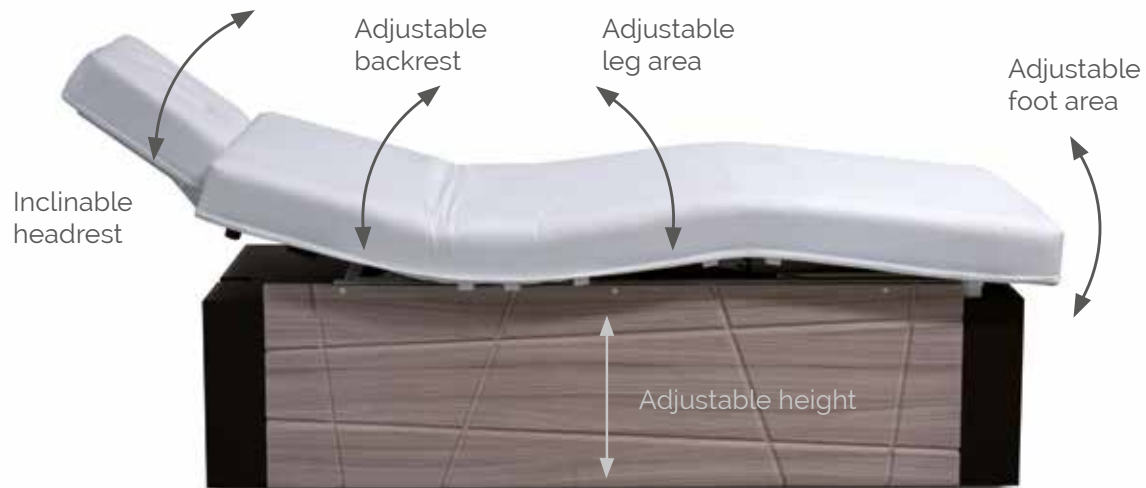

Outstanding: Design & Functionality

In addition to the extraordinary 3D design, the MLW Square also excels thanks to its functionality. For example, the table can be equipped with up to four actuators. This allows it to be set to a height of 54–96 cm. The backrest can be tilted by 70°, the leg section by 25°, the foot section by 18°, and the

head section can be tilted by +/- 30° via a pneumatic spring. The table upholstery can be selected to have a divided version in synthetic leather or a full-length upholstery with a PU cover.







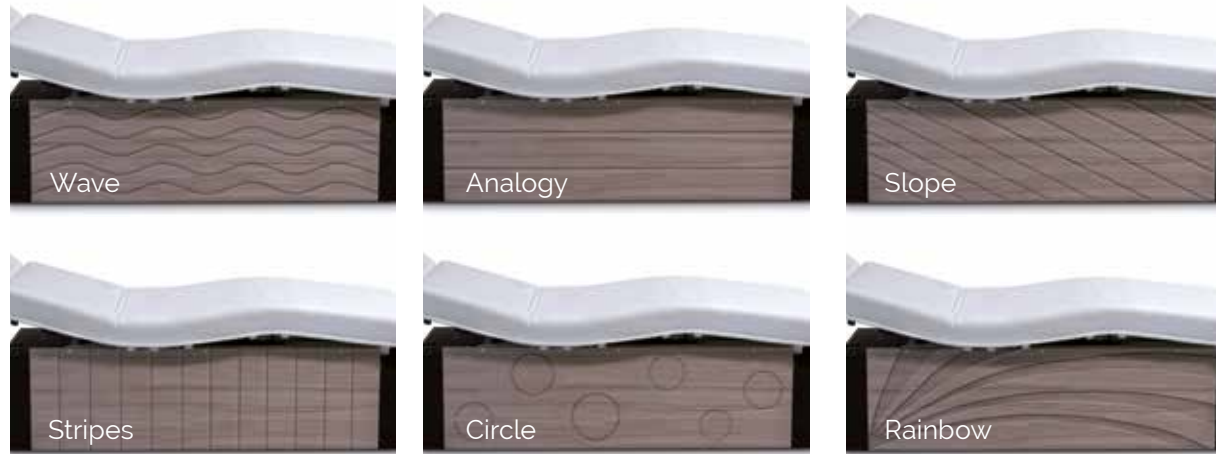





MLW Square 3D-Design

That special something extra: Milled design elements give your MLW Square an individual touch. In addition to the "Illusion" pattern included in the price (see fig. on the left), you can choose your personal favorite from six other designs. 3D pattern



Options (more info. after page 20)

-  Triple-Airback technology: electro-pneumatic 3-zone lordosis support system of the upholstery ---
-  Smart-Thermo: programmable heating system with automatic shut-off ---
-  Vibro-Wellness: gently pulsating vibration system with many adjustment options ---
-  Color upholstery: max. 2 different colors PU, each color ---
-  Synthetic leather standard, per color ---
-  Synthetic leather Ferrari Stamskin Top, per color ---
-  Synthetic leather Ferrari Stamskin One, Macchiato ---
-  Audio-Relax-Headrest: with integrated speakers to connect to common players ---
-  Metal parts in special colors (white, titanium, or dark brown are included in the table price) ---
-  Decor surfaces our collection, (White and wenge are included in the table price) ---
-  Foot switch to control the basic functions ---



Optional armrests

For prone treatments: The optional armrests can be lowered and the tilting head section features a face cradle. The armrests can be removed for cosmetic treatments.



Two upholstery versions

Entirely up to the customer, the MLW Square can be equipped with full-length PU upholstery or a segmented upholstery made from synthetic leather.

Accessories (see also page 154)

- Dentalax neck rest, synthetic leather ---
- Dentalax neck rest, PU ---
- Gel cushions for the face cradle ---
- Terrycloth (white, macchiato, or choco) ---
- Foot protective cover, PVC, transparent ---
- PU protective cover, Art. 49051 ---

Hôtel Barrière Le Fouquet's Paris, France





Photos: © Marc Berenguer

Spa tables Accessories

Upholstery Covers

With the right covers your spa table will always be well protected against different types of stresses and strains. Our table-specific covers fit exactly the individual upholstery segments and thereby the function of the table is not limited.

Thanks to the high-quality terrycloth material, machine washing up to 60° C is possible and therefore hygienic cleaning is possible. Our covers are available in white, choco, and creme.

It is best to order the right cover directly when you buy your table. Our team would be happy to help you decide!

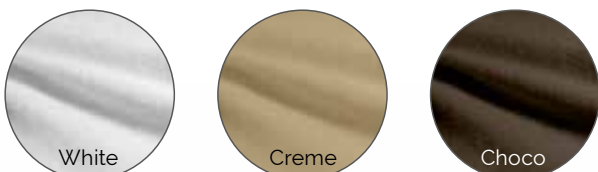

Dentalax Neck Rest

This little tool can significantly improve the comfort of lying on your treatment table. Because the Dentalax supports the position of the neck and helps to stabilize the head. This creates a more comfortable table experience while relieving the neck vertebra. We recommend the Dentalax neck rest for each of our treatment tables as an optimal supplement for the best lying comfort and an increase in treatment ergonomics. The Dentalax is available to match the upholstery color of the table.

- Dentalax with PU, white ---
- Dentalax with PU, choco, creme, or cappuccino ---
- Dentalax with synthetic leather, white ---
- Dentalax with synthetic leather, in standard colors ---
- Dentalax with synthetic leather, in Stamskin colors ---



Foot protective cover

To protect the table areas at the foot end, we offer a suitable protective cover made of robust, transparent PVC for all tables. It can be securely fixed to the upholstery via Velcro.

Protective cover ---



Gel cushion for face cradles

Prevent unpleasant pressure points on the face with this gel cushion. In addition, the gel fluid has a pleasantly cooling effect. The transparent gel cushion can be securely attached to our tables by means of one or two tabs.

- Gel ring with 2 tabs ---
- Gel ring with 1 tab ---



Cover towel with face cradle, large

There is this special single-use cover towel with face cradle for improved hygiene. What makes it special: Thanks to its width, it not only protects the headrest, but also the armrests against contamination. Ideal for all our tables with lowerable armrests or wide head sections. Size: 130 x 35 cm

Package with 50 items, Art. 45310, 1-2 packages, ea. ---

Package with 50 items, Art. 45310, 3-4 packages, ea. ---

Package with 50 items, Art. 45310, 5 packages, ea. ---



Face cradle towels

Extra soft, slotted disposable towel to protect the headrest upholstery; extremely practical and hygienic. Recommended for all headrests with face cradle. Size: 30 x 21 cm

Package with 100 items, Art. 45300 ---



PU protective cover

With this practical cover made of robust PU material, nothing stands in the way of your special treatment any longer. Whether it's oil massages, packs, or the like, the upholstery is always well-protected. The cover has an elastic band to prevent unwanted slipping and can be washed at up to 90 °C. Available in white, choco, or creme.

PU protective cover, Art. 49051 ---



Ayurveda cover

The transparent Ayurveda cover is ideal for pouring oil. It features a drain which allows the oil to be cleanly drained away. The side edge is inflatable allowing the cover be stored to save space after use.

Ayurveda cover, Art. 49050 ---



mikroozid® sensitive

For the gentle and thorough care of our upholstery we recommend mikroozid® sensitive. Available as liquid or ready-to-use cloths in a handy dispenser, it eliminates bacteria, fungi, and viruses (such as HBV, HIV, Rota, vaccinia). Without alcohol!

mikroozid® sensitive wipes, Art. 79418 ---

mikroozid® sensitive liquid, Art. 79417 ---



Loungers



Evo Lounger



RL Aqua



RLX series



Evo Lounger

Evo Lounger

This exclusive lounger offers pure relaxation. Equipped with four actuators, the head, back, leg, and foot sections can be adjusted separately via handheld remote control. The three most common table positions are preset and can be called up at the push of a button. Thanks to its special material, the upholstery is able to perfectly adapt to every body type. With a pull-out shelf on the left and right as well as an LED reading light, the Evo Lounger offers moments of well-being with maximum comfort.

And that little extra: The lounger color can be individually designed. The standard white PU upholstery is also optionally available in creme, choco, black, and macchiato. The casing comes equipped standard in white or with wenge decor. This allows the lounger to integrate perfectly into any atmosphere, making it a truly personalized highlight for any relaxation area.

Features:

- Four actuators for adjusting the head, back, leg, and foot areas.
- Four pre-set positions
- Quilted PU upholstery
- Standard upholstery color: White. Other colors from our color collection for an additional charge
- Base in white or wenge, optional in other decors
- Pull-out tray on both sides
- Optional LED reading light



- Lounger surface height: approx. 50 cm
- Length: 205 cm
- Width: 85 cm
- Load capacity of the table surface: 250 kg



Evo Lounger

4-actuator

Evo Lounger

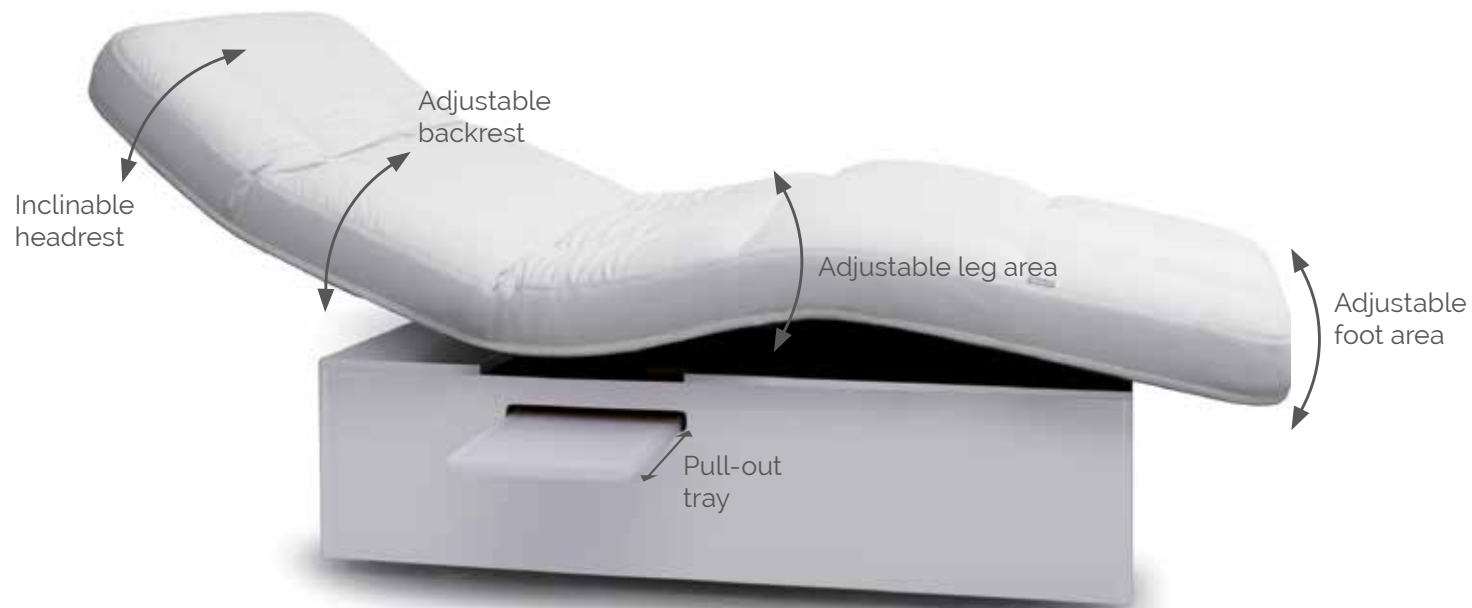

Relaxing lounger comfort

With four actuators and a handheld remote control, the Evo Lounger can be easily adjusted for optimal lying comfort. The head section can be raised by 35°, the back by 50°, the leg section by 20°, and the foot section by 18°. In addition, the

upholstery adapts to each customer individually and thus provides an additional relaxation factor. And the practical trays on both sides of the lounger can be easily pulled out with a handle.



LED reading light

Equipped with a LED reading light, the lounge offers everything your customers need for a relaxing break (picture similar).



Pull-out tray

The pull-out tray on both sides is the perfect spot for setting something down or putting something away while reading with a wellness beverage.



Multimedia sound system







The integrated multimedia sound system allows you to load relaxing sounds and music on demand.



Easy to use

Three preset lounge positions can be accessed at the simple press of a button. Of course, the Evo Lounger is also individually adjustable.

Options (more info. after page 20)

-  Triple-Airback technology: electro-pneumatic 3-zone lordosis support system of the upholstery ---
-  Smart-Thermo: programmable heating system with automatic shut-off ---
-  Vibro-Wellness: gently pulsating vibration system with many adjustment options ---
-  Color upholstery: max. 2 different colors PU, each color ---
-  Multimedia sound system Audio-Relax-Headrest ---
-  Decor surfaces our collection, (White and wenge are included in the table price) ---

Accessories

- Dentalax neck rest, PU ---
- Foot protective cover, PVC, transparent ---

Kempinski Hotel Grand Arena Bansko Bulgaria



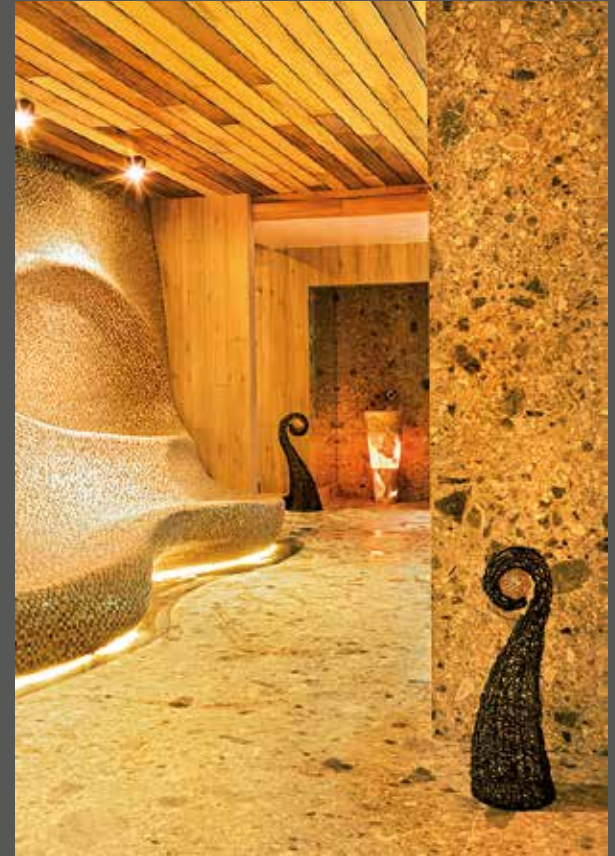

Photos: © Kempinski Hotel Grand Arena Bansko



RL Aqua



RL Aqua

This lounge offers pure relaxation "with water." For the best possible comfort, the heated waterbed also has an intermediate layer of foam. The robust and easy-to-clean synthetic leather surface is available in various colors. Accessories include a matching cushion and a knee roll. The RL Aqua is available in different dimensions for an additional charge.

Features:

- Heated water bed
- Soft intermediate layer of foam
- Easy-to-clean synthetic leather surface
- Standard upholstery color: White. Other colors from our color collection for an additional charge
- Base in white or wenge, optional in other decors
- Optionally in various lengths and widths

RL Aqua

Including heating



- Access height: 49 cm
- Length: 202 cm
- Width: 91 cm
- Load capacity of the table surface: 160 kg

Options (more info. after page 20)



- Synthetic leather standard, per color
- Synthetic leather Ferrari Stamskin Top, per color



- Metal parts in special colors (white, titanium, or dark brown are included in the table price)



- Decor surfaces: our collection, (White and wenge are included in the table price)

AIGO welcome family****S
Aigen-Schl\"agl, Austria





Photos: © MLK Hotel Betriebs GmbH

RLX series



RLX series

The RLX, with its soft and easy-to-clean synthetic leather upholstery is specially designed for the rest area of a spa. With its exceptional design and different equipment options, the lounge fulfills all desires. For example, the motorized tilt adjustment makes the RLX Electric a truly unique lounge. This lounge, like the RLX as well, can also come with heating upon request.

With optional reading light and removable neck cushion, the RLX models are the perfect solution for pleasant relaxation.

Features:

- Lounge in three versions
- Extraordinary design
- Choose from numerous design variants
- Easy-to-clean synthetic leather cover
- Standard upholstery color: White. Other colors from our color collection for an additional charge
- RLX Electric with electrical lounge surface adjustment
- Firm lounge surface position on RLX and RLX Light
- Heating optional for RLX and RLX Electric lounge surface
- Choose from short or long standpipes at the base
- Optional color-matched neck rest
- Optional LED reading light

RLX + RLX Electric

- Access height: 45 cm
- Projection length: 190 cm
- Width: 70 cm
- Load capacity of the table surface: 160 kg



RLX Light

- Access height: 38 cm
- Projection length: 174 cm
- Width: 66 cm
- Load capacity of the table surface: 160 kg



RLX Electric

1 actuator



RLX

Without actuators



RLX Light

Without actuators



RLX series



The models to choose from

With their high-end design and high degree of quality, the RLX models truly stand out. While the position of the lounge surface is fixed with the RLX and RLX Light, on the RLX Electric the lounge surface can be electrically adjusted. You're not just choosing "your" model, but also the best upholstery color and coating of the metal parts for your at-

mosphere – for your relaxation area's perfect look. With optional extras such as the Smart Thermo heating system for a comfortable temperature of the lounge surface, downtime on the RLX for your customers becomes a real relaxation experience!



LED reading light

The optionally available LED light for reading makes relaxation time on the RLX even more enjoyable for your customers. Its flexible neck makes it easy to put it in the right position.



Removable neck cushion

The neck cushion, which can be easily removed if necessary, offers perfect lying comfort. It can be optimally positioned via a Velcro fastener.



Standpipes in various lengths



Select the length of your standpipes and thus the design of your lounge model. By the way: For an appealing look, the color of the standpipe end caps corresponds to that of the lounge upholstery.



Especially stable

An elegant appearance combined with maximum stability - this is ensured by the sophisticated metal construction of the RLX. This can optionally be coated in your personally favorite color.

Options (more info. after page 20)

- 
Smart-Thermo: programmable heating system with automatic shut-off (not for RLX Light) -.-
- 
Color upholstery: max. 2 different colors
 Synthetic leather standard, per color -.-
 Synthetic leather Ferrari Stamskin Top, per color -.-
- 
Metal parts in special colors (white, titanium, or dark brown are included in the table price) -.-

Accessories

- Neck cushion, white -.-
- Neck cushion, in colors -.-
- LED reading light -.-
- Foot protective cover, PVC, transparent -.-

SeaHill Spa at The Cavalier Hotel, Autograph Collection Hotel, USA





Photos: © SeaHill Spa

Massage Tables



MLW Transform



Ellipse



RLL



ML series



Ayurveda



Shiatsu mat

MLW Transform



MLW Transform

The MLW Transform gives the term "feel-good sofa" a whole new dimension, because this high-end couch transforms into a massage table in no time.

The massage table, with its independent battery and pull-out cable is of course height-adjustable and can be heated for a cozy, feel-good experience. For optimum comfort, the head section can also be adjusted for height and inclination. If you need more seat space, the three cushions on the backrest of the couch can simply be removed. The high-quality, elegant synthetic leather cover of the upholstery is available in various decors and colors. For a very personalized look, the sofa can also be equipped with a leather cover or a (customer's) cover fabric on request.

Features:

- Massage table and sofa in one
- Pull-out massage table
- Height electrically adjustable
- Electrically extending lightweight castors
- With integrated battery and power connection
- Heating optional for lounge surface of the massage unit when plugged in
- Removable, crescent-shaped head section
- Storage compartment in the base
- Robust synthetic leather upholstery in black
- Optional in various decors, leather, or (customer's) cover material
- Three removable cushions on the backrest

MLW Transform

Sofa-massage table combination	---
Individual massage table	---
Sofa as purely seating furniture	---



- Couch height: approx. 80 cm
- Table height: approx. 45-75 cm
- Couch width: approx. 212 cm
- Spa Table:
 - Length without head section: approx. 166 cm
 - Couch depth: approx. 87 cm
 - Spa Table: Width approx. 75 cm
 - (Recommended) lifting capacity: 250 kg
 - Load capacity of the table surface: 300 kg

MLW Transform

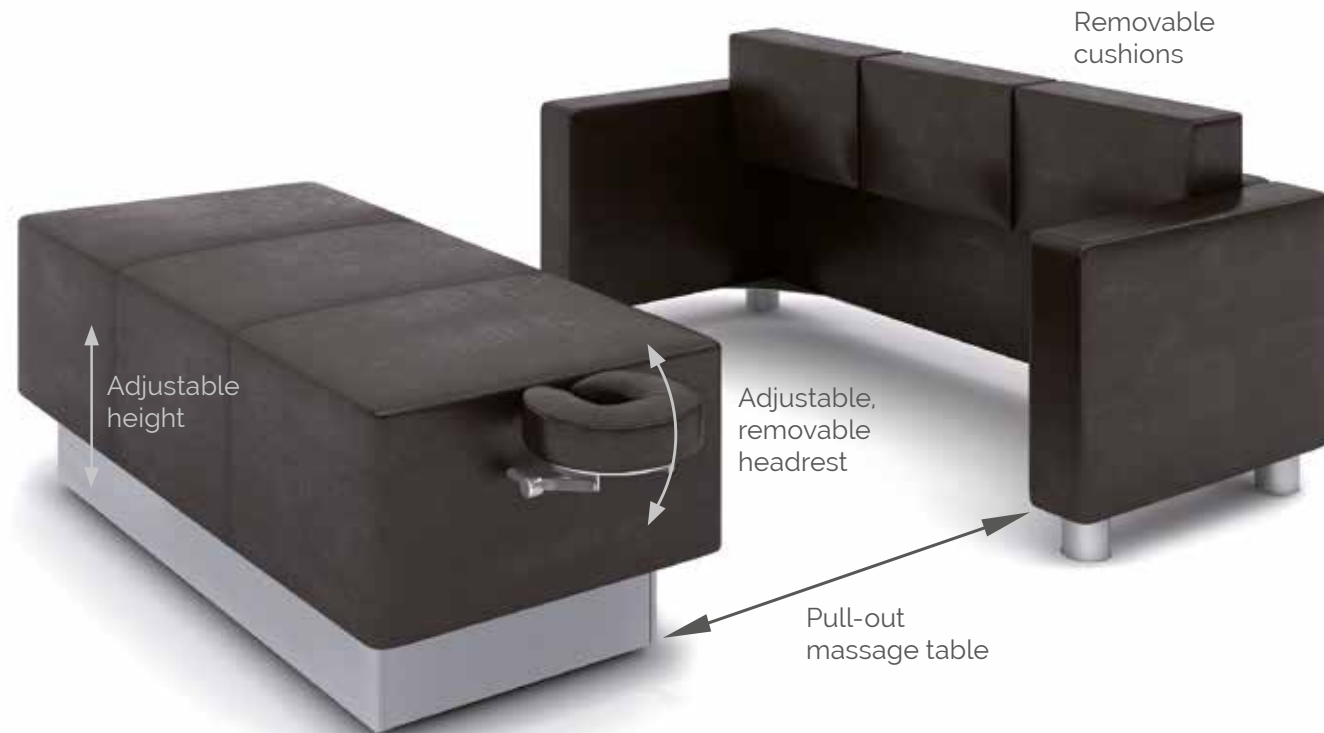

Two-in-one

The high-end "feel-good sofa" can easily transform into a massage table: Pull out with the electrically retractable lightweight castors and attach the adjustable crescent-shaped head section – done! For massage treatments, the height can be adjusted electrically from 45-75 cm. In addition to a cord connection, the MLW Transform also has a battery and can thus be used away from a wall power outlet. With the optional Smart-Thermo feature, you can also ensure a cozily warm table experience during operation while plugged in.

on to a cord connection, the MLW Transform also has a battery and can thus be used away from a wall power outlet. With the optional Smart-Thermo feature, you can also ensure a cozily warm table experience during operation while plugged in.



Flexible headrest

The crescent-shaped, adjustable headrest is easy to put on – the massage table is ready!



Practical storage compartment

With a practical storage compartment in the base of the massage unit, the headrest is always ready at hand.



Battery operation

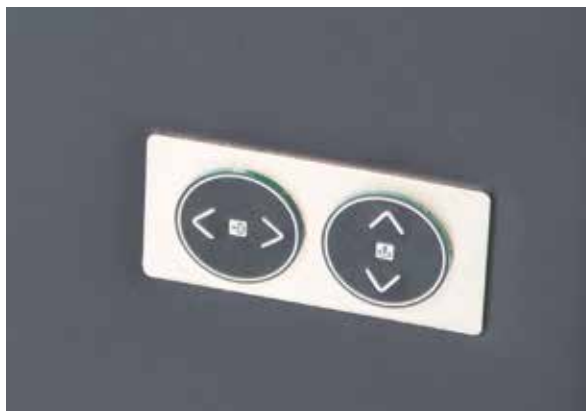

With its integrated battery, the MLW Transform can be used independently of a wall power outlet. It is charged via the pull-out power cord.



Easy to use

Thanks to the integrated touch panel, the electrically extendable lightweight castors can be easily activated and the height of the table surface can be adjusted.

Options (more info. after page 20)

-  Smart-Thermo: programmable heating system with automatic shut-off ---
-  Color upholstery: max. 2 different colors
Synthetic leather Ferrari Stamskin Top, per color ---
-  Decor surfaces: our collection,
(White and wenge are included in the table price) ---

Ellipse



Ellipse

This massage table features by an extraordinary elliptical upholstery. This makes treatments on the head, neck, and legs much easier to perform. In addition, the Ellipse, with its slender double lifting columns, not only offers electrical height adjustment, but also the greatest possible legroom. The height of the back section can also be adjusted ergonomically via pneumatic spring.

The matching oval base of the table ensures maximum stability thanks to its sturdy steel construction, with the wood trim case giving it a particularly elegant touch.

With the upholstery in a PU or synthetic leather version and an optional special coating of the metal parts, the ellipse can be color-matched to any interior. In addition, the extras, including Smart-Thermo, a programmable heating system and the gently oscillating Vibro-Wellness-System make the Ellipse an extraordinary feel-good highlight for every work-space.

Features:

- Elliptical upholstery
- Double lifting column technology
- Electrical height adjustment
- Back section adjustable via pneumatic spring
- Foot with wood decor case
- Base in white or wenge, optional in other decors
- With classic synthetic leather or PU upholstery
- Standard upholstery color: White. Other colors from our color collection for an additional charge



- Height: 61-101 cm
- Length: 194 cm
- Width: 78 cm
- Head section length: 66 cm
- Table surface length: 128 cm
- (Recommended) lifting capacity: 300 kg
- Load capacity of the table surface: 350 kg

Ellipse

2-actuator

Options (more info. after page 20)

- Smart-Thermo: programmable heating system with automatic shut-off ---
- Vibro-Wellness: gently pulsating vibration system with many adjustment options ---
- Color upholstery PU: max. 2 colors possible, each color ---
- Metal parts in special colors (white, titanium, or dark brown are included in the table price) ---
- Decor surfaces: our collection, (White and wenge are included in the table price) ---
- Foot switch to control the basic functions ---

Accessories (see also page 200)

- Dentalax neck rest, PU ---
- Gel cushions for the face cradle ---
- Terrycloth (white, macchiato, or choco) ---
- PU protective cover, Art. 49051 ---



RLL series



RLL Series

As a massage bench, the "RLL Round" and "RLL Square" double lifting column technology allows for fast and easy adjustment without any effort. At the same time, their base, with its solid steel construction, ensures maximum stability.

In terms of technology and functionality, both models can be customized. For example, they can be equipped with "Smart-Thermo," an integrated heating system for a comfortable temperature-controlled table surface and/or with "Vibro-Wellness," a gently oscillating vibration system with numerous adjustment options. In addition, the RLL models are available in two upholstery versions.

Features:

- Massage bench with double lifting column technology
- Base with solid steel construction for maximum stability
- Electrical height adjustment
- Back section adjustable via pneumatic spring
- Available in different versions
- With classic synthetic leather or PU upholstery
- Angular or rounded upholstery form
- Standard upholstery color: White. Other colors from our color collection for an additional charge



- Height: 57-103 cm
- Length: 198 cm
- Width: 75 cm
- Head section length: 66 cm
- Table surface length: 132 cm
- (Recommended) lifting capacity: 300 kg
- Load capacity of the table surface: 350 kg



RLL Round

1 actuator



RLL Square

1 actuator

Options (more info. after page 20)

- Smart-Thermo: programmable heating system with automatic shut-off ---
- Color upholstery: max. 2 different colors PU, each color ---
- Synthetic leather standard, per color ---
- Synthetic leather Ferrari Stamskin Top, per color ---
- Synthetic leather Ferrari Stamskin One, Macchiato ---
- Logo embroidery: depending upon cost ---
- Metal parts in special colors (white, titanium, or dark brown are included in the table price) ---
- Foot switch to control the basic functions ---

Accessories (see also page 200)

- Dentalax neck rest, synthetic leather ---
- Dentalax neck rest, PU ---
- Gel cushions for the face cradle ---
- Terry cloth (white, macchiato, or choco) ---
- Foot protective cover, PVC, transparent ---
- PU protective cover, Art. 49051 ---

Thermen Bussloo

Voorst, Netherlands





ML series



ML series

All tables in the ML series are electrically height-adjustable. The head section can be inclined pneumatically via pneumatic spring by +/-30°. In the two-actuator version, the head area of the MLK can be adjusted electrically as well as on the MLL. The MLK ABS and MLK Physio are equipped with armrests that can lower you for prone treatments, while the MLL offers a larger head section. The base is available in both white (standard) and titanium (optional).

Features:

MLK ABS

- Electrical height adjustment
- Lowerable armrests
- Head section with face cradle inclinable +/-30°
- White synthetic leather upholstery, optional in other colors

MLK Physio

- Electrical height adjustment
- electrical adjustment of the elevated center position
- Lowerable armrests
- Head section with segmented face cradle inclinable +/-30°
- White synthetic leather upholstery, optional in other colors

MLK

- Electrical height adjustment
- Head section with face cradle inclinable +/-30° via pneumatic spring (optional electric)
- White synthetic leather upholstery, optional in other colors
- Short head section with face cradle

MLL

- Electrical height adjustment
- Head section inclinable +/-30° via pneumatic spring (optional electric)
- White synthetic leather upholstery, optional in other colors
- Long head section with face cradle



- Height: 61-91 cm
- Length: 196 cm
- MLK (ABS) head section length: 42 cm
- MLL head section length: 67 cm
- Width: 70 cm
- (Recommended) lifting capacity: 200 kg
- Load capacity of the table surface: 250 kg



MLK ABS

1-actuator (height)



MLK Physio

2-actuator (height, elevated center)



MLL

1-actuator (height)

2-actuator (height, head section)



MLK

1-actuator (height)

2-actuator (height, head section)

ML series



The massage specialists

The "MLK ABS," "MLK Physio," "MLK," and "MLL" massage tables are electrically height-adjustable from 61-91 cm and their head section can be tilted via pneumatic spring; on the MLL and MLK this is +/- 30° also possible electrically on

the two-actuator version. The MLK ABS and MLK Physio are also equipped with lowerable armrests, with the MLK Physio also having a segmented table surface for setting an elevated center position.

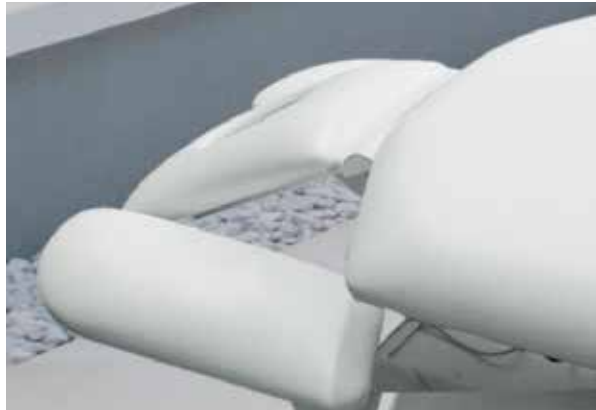

For prone treatments

The MLK ABS and MLK Physio models are equipped with lowerable armrests and a downwards and upwards tilting headrest with face cradle. This makes them suitable for all prone treatments.



Special elevated center position

To provide relief for your customer's lumbar spine area, the table surface can be brought into an elevated center position by the motor on the MLK Physio.



Paper roll holder











With a paper roll holder mounted at the foot of the table, you can always pull protective paper over the table.



Everything within reach

The compartment under the MLK and MLK ABS serves as a handy storage space, e.g. for hand towels. If necessary, the compartment can be supplemented with a second shelf.

Options (more info. after page 20)

-  Smart-Thermo: programmable heating system with automatic shut-off ---
-  Color upholstery: max. 2 different colors ---
-  Synthetic leather standard, per color ---
-  Synthetic leather Ferrari Stamskin Top, per color ---
-  Synthetic leather Ferrari Stamskin One, Macchiato ---
-  Logo embroidery: depending upon cost ---
-  Base casing in titanium color ---
-  Castor set, brakable, Art. 73006 ---
-  Foot switch to control the basic functions on the single-actuator version ---
-  Foot switch to control the basic functions on the two-actuator version ---

Accessories (see also page 200)

- Dentalax neck rest, synthetic leather ---
- Dentalax neck rest, PU ---
- Gel cushions for the face cradle ---
- Terrycloth (white, macchiato, or choco) ---
- Foot protective cover, PVC, transparent ---
- PU protective cover, Art. 49051 ---

Wanderhotel Gassner

Neukirchen am Großvenediger, Austria





Photos: © Hotel Gassner GmbH & Co KG



Ayurveda Table

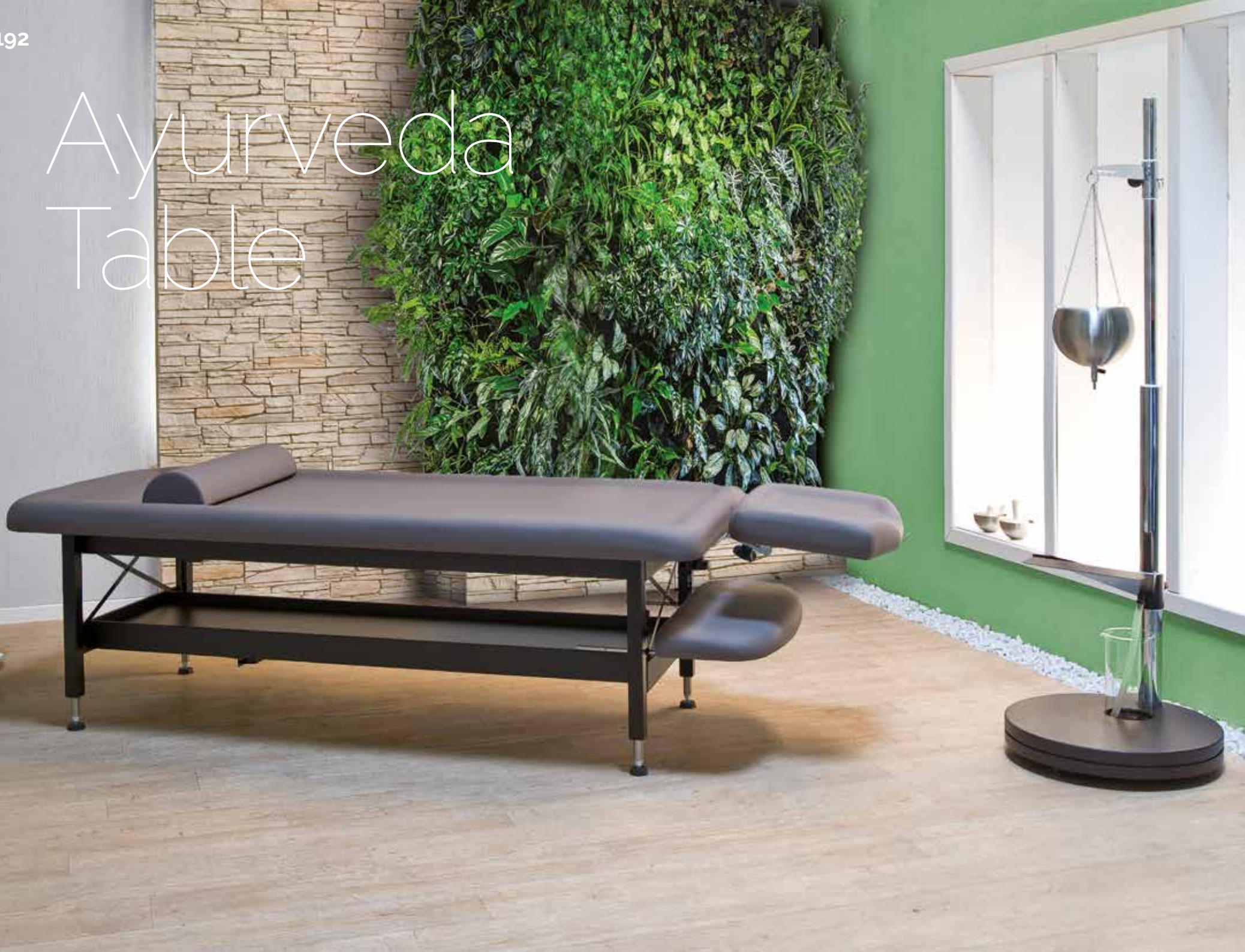

Ayurveda Table

Thanks to its special design, this table is suitable for all Ayurvedic treatments. The upholstery features a raised edge for use with larger quantities of oil and an oil-resistant PU cover. The accompanying four-piece PU accessory set consists of an Ayurveda half roll, a crescent-shaped massage headrest, an armrest, and a headrest with drainage device.

The table height can be manually adjusted hydraulically or electro-hydraulically. The large shelf below the bed can be used for everything you need for treatment.

Features:

- Upholstery especially for Ayurvedic treatment methods
- Elevated upholstery edge for use of larger amounts of oil
- Oil-resistant PU cover
- With hydraulic or electro-hydraulic height adjustment
- Four-piece PU accessory set with Ayurveda half roll, special headrest with drain, crescent-shaped massage headrest, and armrest

Ayurveda Table

Electrohydraulic, Art. 49043

Hydraulic, Art. 49042



- Height (without edge): 58-88 cm
- Length: 200 cm
- Width: 85 cm
- (Recommended) lifting capacity: 200 kg
- Load capacity of the table surface: 200 kg

Ayurveda Table



The oil can flow here

The height of the Ayurveda table can be adjusted hydraulically by hand crank or electro-hydraulically by pressing a button from 58 -88 cm. The headrest can be tilted up and

down and the armrest can be attached at different heights. For the use of larger quantities of oil, the seat cushion is equipped with a raised edge and an oil-resistant PU cover.



Perfect for oil treatments

The head section is designed so that the oil can run off cleanly during forehead pouring.



Headrest for massages

With the crescent-shaped, tiltable, and removable headrest with face cradle, massage treatments can also be performed prone.



Pull-out armrest

The armrest can be mounted at two different heights or completely removed. There is enough space there if the customer is lying prone.



Practical storage shelf

On the surface below the table, you can store or set aside everything important for your treatments.

Options (more info. after page 20)



Smart-Thermo: programmable heating system with automatic shut-off

Accessories (see also page 200)

Oil-resistant protective cover, washable, choco, Art. 49051

Face cradle towels, 100 pieces, Art. 45305

Washable fleece, 10 pieces, Art. 45302

Fleece cover, 10 pieces, Art. 45303

Preidlhof Luxury DolceVita Resort Narnano, Italy





Photos: © Lorenz Masser / Preidlhof Spa Hotel www.jamesbedford.com



Shiatsu mat

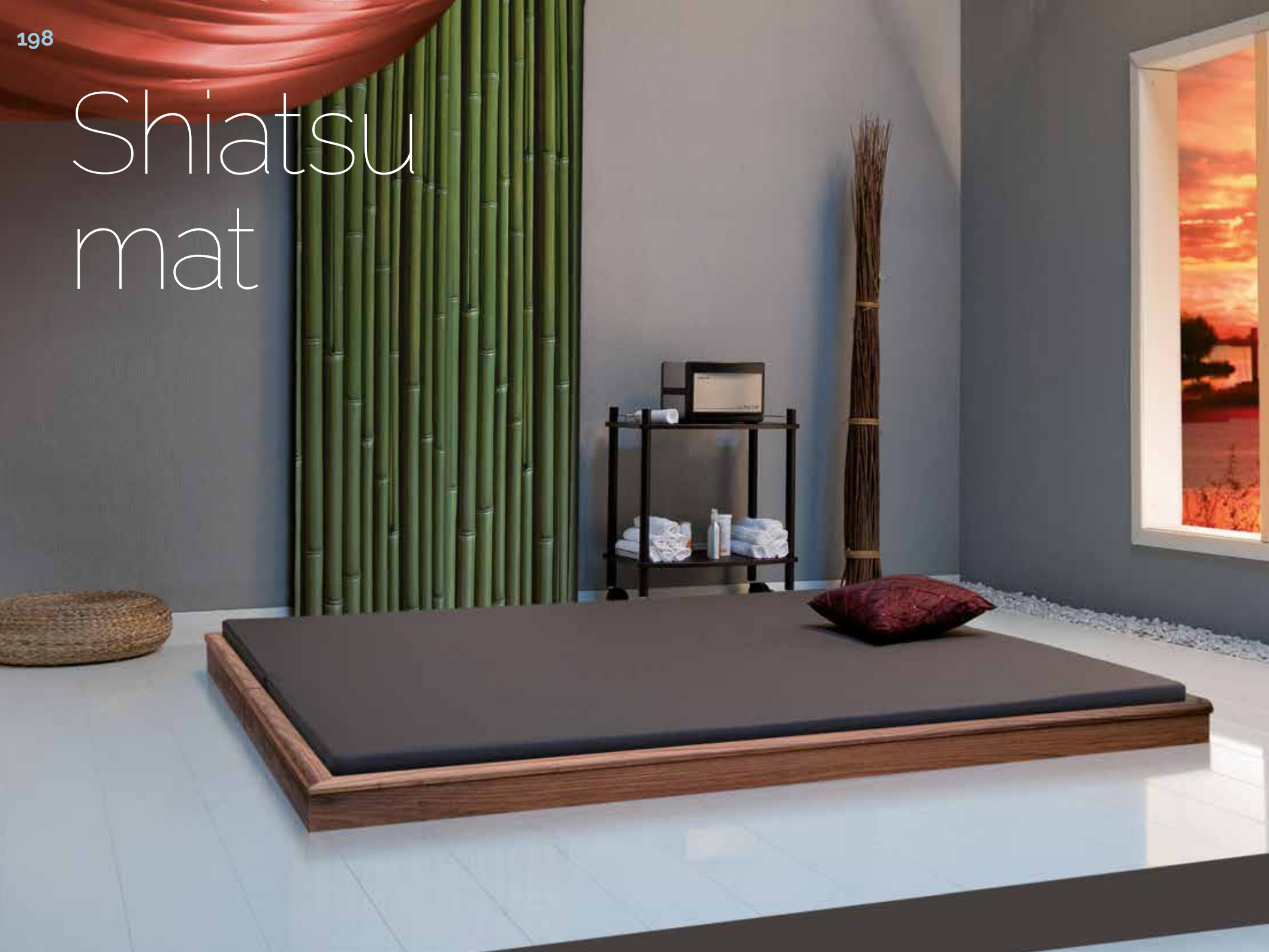



Shiatsu mat

Do you prefer relaxing shiatsu massages, a form of energetic body work developed in Japan? Then we have a practical solution for you: A Shiatsu mat with skin-friendly and hygienic PU cover in the color Choco. The mat with firm foam filling is collapsible and the optional real wood frame is easy to share. In addition, the high-end frame is available in different colors. On request, it can also be equipped with an LED light bar. This way you can create a very special, atmospheric ambience!

Features:

- Collapsible
- Firm foam filling
- PU cover optional in five different colors
- Optional high-end real wood frame in different colors
- LED light bar optional

Options (more info. after page 20)

-  Color upholstery PU: max. 2 colors possible, each color ---
-  Other frame woods and coatings ---
-  LED lighting in the frame ---



- Mat thickness: 8 cm
- Width: 180/90 cm
- Depth: 200 cm



Shiatsu mat	
Without frame	---
With frame	---

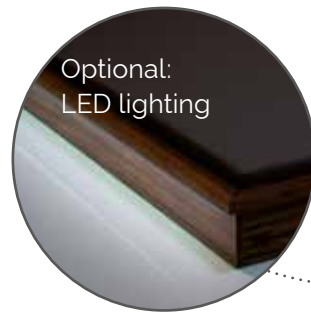

Massage Tables Accessories

Upholstery Covers

With the specially adapted covers your massage table is always well protected against different types of stress. The table-specific covers are an exact match to the individual upholstery segments.

Thanks to the high-quality terrycloth material, machine washing up to 60° C is possible and therefore hygienic cleaning is possible. With their integrated elastic bands, the individual segments stay exactly where they belong, thus preserving the function of the tables.

Our covers are available in three colors: White, choco, and macchiato.

It is best to order the right cover directly when you buy your table. Our team would be happy to help you decide!



Roll holder including 1 paper roll

The optional paper roller provides you with a practical, disposable protection for your table. As needed, the 50 cm wide paper is unrolled and pulled over the lying surface. After use simply tear it off at the perforation line and discard. A neat thing!

- Roll holder including 1 paper roll, Art. 42064 ---
- Sanitary paper roll, 50 x 0.5 m, Art. 42065, up to 8 pieces, ea. ---
- Sanitary paper roll, 50 x 0.5 m, Art. 42065, 9 pieces, ea. ---



Face cradle towels

Extra soft, slotted fleece disposable towel to protect the headrest; extremely practical and hygienic. Recommended for all headrests with face cradle. Size: 30 x 21 cm

Package with 100 items, Art. 45305



Practical disposable towel specially for u-shaped headrests. Thanks to the one-sided opening in the towel, it can be perfectly adapted to the massage head rest.

Package with 100 items, Art. 45301



Cover towel with face cradle, large

There is this special single-use cover towel with face cradle for improved hygiene. The special thing about it: its width not only protects the headrest but also the armrests against contamination. Ideal for all our tables with lowerable armrests or wide head sections. Size: 130 x 35 cm

Package with 50 items, Art. 45310



mikrozyd® sensitive

For the gentle and thorough care of our upholstery we recommend mikrozyd® sensitive. Available as liquid or ready-to-use cloths in a handy dispenser, it eliminates bacteria, fungi, and viruses (such as HBV, HIV, Rota, vaccinia). Without alcohol!

mikrozyd® sensitive wipes, Art. 79418

mikrozyd® sensitive liquid, Art. 79417

Washable fleece

Practical and comfortable cotton wool table cover. The material is washable up to 10 times. 80 x 200 cm

Package with 10 pieces, Art. 45302



Treatment beds

Our treatment beds are functional and flexible. The seats are versatile and adjustable and can be controlled by hand switch. Depending on the bed model, up to eight positions can be saved via memory function. The quality actuators from Linak have the "Spline" safety feature, which prevents the danger of crushing on moving parts. For non-actuator-driven table parts, Stabilus pneumatic springs provide easy adjustment without much effort.

The construction of the tables was designed taking ergonomic aspects into account. Numerous elaborate details, such as the optional Rotonde turning function, make the job easier. Pull-out head and foot sections provide comfort to customers of all body types.

A particular highlight is the Airback®, a lumbar support system whose adjustment is controlled by air pressure via a

hand pump. Airback® comes standard in all treatment beds. The treatment beds always come equipped with a white Gharieni synthetic leather upholstery. Here you can choose from a large number of colors in addition to the standard

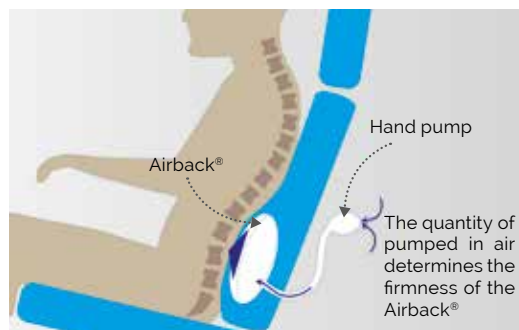

equipment. These can be found in the rear flap of the catalog. Choose your favorite from the Gharieni color chart or from the exclusive Ferrari Stamskin top collection! On some bed models, you can put together your own personalized bed from up to three different colors. The casing is made from robust, easy-to-clean, and colorfast plastic. It is available on almost all models in addition to the standard white in titanium.

The options table will show you which equipment options you have that can be found on the corresponding beds. The individual options are then page 20 explained from there. You can find an extensive list of accessories at the end of each bed section.



Lina Select series



SPL Sphinx



SPL series



SPX series



SL XP series



SLR



LR



Hydraulic series

Lina Select series



Lina Select series

Slim, elegant design, maximum comfort and variability. – Our Lina Select series is the ultimate for you as a beautician! Because the innovative Lina's program is "Select," which combines optimal working and table comfort as well as individual versatility.

You can thus choose from the following versions of the one-piece upholstery cover with memory foam:

- Standard – the perfect "bottom layer" for massages
- Soft – for even more comfort, even with time-consuming cosmetic treatments

Particularly practical: On all models, the armrests for massage treatments feature double-sided upholstery and can be folded down. In addition, the head and foot sections can be pulled out and removed. And of course you can adjust the height, inclination, back, and leg sections electrically and store up to four positions. In addition, the bed can be equipped with the upholstery-warming Smart-Thermo heating system. All Lina Select models are also available as Podo version with segmented foot section.

Lina Select Alu

The Lina Select Alu features a sophisticated designer aluminum base with upholstery or wood applications.

Properties:

- Aluminum-cladded base
- With side wood or synthetic leather applications
- Pull-out and removable head and foot sections
- Electrical height, back, and seat adjustment
- Including designer hand switch with memory function to store four bed positions
- Fold-down armrests upholstered on both sides
- Vertically adjustable foot section
- Upholstery with a memory foam layer
- Upholstery sewn into one piece
- "Airback" lordosis support system integrated into the upholstery (see page 202)



- Height: 54-96 cm
- Bed surface length: max. 202 cm
- Width without/with armrests: 62/80 cm
- (Recommended) lifting capacity: 200 kg
- Load capacity of the seat: 250 kg



Lina Select Alu
with standard upholstery



Lina Select Alu including
Alu Design hand switch

Lina Select Alu

4-actuator, incl. designer hand switch



Lina Select Alu
with Soft upholstery

Lina Select Wood

Equipped with the same features as the other Lina Select models, the Lina Select Wood has a delicate, yet stable base. The foot is available in one of our numerous wood decors. This allows the bed to be perfectly adapted to your interior design – giving your workspace a particular bit of elegance.

Properties:

- Delicate foot with wood decor in wenge or white
- Additional decors optionally available
- Pull-out and removable head and foot sections
- Height, back, seat inclination, and leg section electrically adjustable via hand switch
- Vertically adjustable foot section
- Upholstery sewn into one piece
- Standard upholstery color: White. Other colors from our color collection for an additional charge
- With a memory foam layer
- Fold-down armrests upholstered on both sides
- "Airback" lordosis support system integrated into the upholstery (see page 202)



Lina Select Wood with standard upholstery

Lina Select Wood
4-actuator



Lina Select Wood with Soft upholstery

 • Height: 54-96 cm
 • Bed surface length: max. 202 cm
 • Width without/with armrests: 62/80 cm
 • (Recommended) lifting capacity: 200 kg
 • Load capacity of the seat: 250 kg

Lina Select Static

With its one-pillar technology and solid floor installation, the Lina Select Static looks particularly elegant. At the same time it gives you practical legroom with maximum stability. In addition, this model has the same features as the "Wood" and "Alu."

Properties:

- Bolted to the floor for maximum stability and legroom
- Four-actuator
- Height, back, seat inclination, and leg section electrically adjustable via hand switch
- Vertically adjustable foot section
- Pull-out and removable head and foot sections
- Upholstery sewn into one piece
- Standard upholstery color: White. Other colors from our color collection for an additional charge
- With a memory foam layer
- Fold-down armrests upholstered on both sides
- "Airback" lordosis support system integrated into the upholstery (see page 202)



Lina Select Static
with standard upholstery

Lina Select Static
4-actuator



Lina Select Static
with Soft upholstery



- Height: 54-96 cm
- Bed surface length: max. 202 cm
- Width without/with armrests: 62/80 cm
- (Recommended) lifting capacity: 200 kg
- Load capacity of the seat: 250 kg

Lina Select series



Extraordinarily variable

All of the Lina Select series models are extraordinarily versatile. The height is adjustable from 54-96 cm and the head and foot sections can each be pulled out by 10 cm. The backrest can be set up to 70° and the seat can be tilted by

25°. In addition, the leg area can be tilted down by 75°. And for massage treatments, the double-upholstered armrests can be folded down.



High-end application

The sides surfaces of the foot of the Lina Select Alu feature the same synthetic leather as the bed upholstery. Optionally, however, it is also possible to choose an elegant wood decor.



Usable on both sides

Particularly practical: On all Lina Select models, the armrests feature double-sided upholstery and can be folded down. This allows them to be used for prone massage treatments.



Lightweight, elegant, & stable

The foot of the Lina Select Wood looks elegant, but at the same time it is extremely stable. With a wood decor of your choice, the bed can be perfectly adapted to the ambience of your workspace.



Dentalax Neck Rest

Indispensable for a pleasant treatment: the Dentalax neck rest. It supports the position of the neck and the head and thus ensures maximum comfort.

Options (more info. after page 20)

	Soft Upholstery	---
	Smart-Thermo: programmable heating system with automatic shut-off	---
	Vibro-Wellness: gently pulsating vibration system with many adjustment options	---
	Color upholstery: max. 2 different colors PU, each color	---
	Synthetic leather standard, per color	---
	Synthetic leather Ferrari Stamskin Top, per color	---
	Synthetic leather Ferrari Stamskin One, Macchiato	---
	Logo embroidery: depending upon cost	---
	XL EXTENSION Attachment to expand the bed in the upper back area	---
	Color XL Extension: max. 2 diff. colors	---
	Synthetic leather standard, per color	---
	Synthetic leather Ferrari Stamskin Top, per color	---
	Wood application our collection,	---
	Hand switch with memory function: Up to four bed positions can be stored (included in the price of Lina Select Alu)	---
	Castor set, brakable, Art. 73006	---
	Foot switch memory function: for controlling the basic functions and the memory positions	---

Accessories (see also page 252)

	Dentalax neck rest, synthetic leather	---
	Dentalax neck rest, PU	---
	Terrycloth (white, macchiato, or choco)	---
	Foot protective cover, PVC, transparent	---

Praxisklinik MKG-Chirurgie Pescheck/Romsdorfer Schwäbisch Hall, Germany





SPL Sphinx



SPL Sphinx

The four-actuator SPL Sphinx combines all the advantages of a treatment bed and spa table. As a successful "fusion" it excels in three ways: It allows you to do your best work. Your customers will be pampered with luxurious table comfort, while at the same time providing an elegant look for your workspace.

With its newly designed Comfort Soft upholstery including the mechanical Airback as well as its armrests upholstered on both sides, the SPL Sphinx is suitable for almost all treatments — a real plus for every studio!

Features:

- Newly-designed upholstery
- Compact base with wood decor applications
- Extraordinary design
- Height, back, seat inclination, and leg section electrically adjustable via hand switch
- Pull-out foot and head sections
- Armrests upholstered on both sides can be folded back
- Eight freely selectable memory positions
- Hand switch with locking feature
- Spline safety actuators to avoid the danger of crushing
- Comfort Soft upholstery made from synthetic leather or PU
- Standard upholstery color: White. Other colors from our color collection for an additional charge
- "Airback" lordosis support system integrated into the upholstery (see page 202)



- Height: approx. 56-92 cm
- Length: approx. 144-200 cm
- Width without/with armrests: approx. 66/80 cm
- (Recommended) lifting capacity: 200 kg
- Load capacity of the seat: 250 kg



SPL Sphinx

4-actuator



SPL Sphinx



Treatment bed with a spa flair

The base with wood applications creates the perfect symbiosis of elegance and functionality. The bed height can be set to 56-92 cm. The backrest can be set up to 70° and the seat can be tilted by 20°. To facilitate access, the foot section

can be angled down to 75°. Headrest and footrest can be extended up to 10 cm, and the armrests can be folded down backwards.





Metal-wood combination

With its metal-wood combination at the base, the SPL Sphinx has the flair of a spa table and yet still has the functionality of a treatment bed. The perfect symbiosis!



Extra-flat feet

No more tripping hazards, absolute freedom of movement, and a real eye-catcher at that: The ultra-flat feet of the SPL Sphinx ensure excellent stability.



Armrests upholstered on both sides











Particularly practical: For massage treatments, the armrests upholstered on both sides can be folded down.



Dentalax Neck Rest

Indispensable for a pleasant treatment: the Dentalax neck rest. It supports the position of the neck and head. This ensures the highest level of table comfort.

Options (more info. after page 20)

-  Airback electrical: electro-pneumatic lordosis support system of the upholstery ...
-  Smart-Thermo: programmable heating system with automatic shut-off ...
-  Vibro-Wellness: gently pulsating vibration system with many adjustment options ...
-  Color upholstery: max. 2 different colors
Synthetic leather standard, per color ...
Synthetic leather Ferrari Stamskin Top, per color ...
Synthetic leather Ferrari Stamskin One, Macchiato ...
-  Logo embroidery: depending upon cost ...
-  Multifunctional headrest:
Joint mounting, stainless steel ...
Crescent-shaped attachment ...
U-shaped attachment ...
-  XL EXTENSION Attachment to expand the bed in the upper back area ...
-  Color XL Extension: max. 2 diff. colors
Synthetic leather standard, per color ...
Synthetic leather Ferrari Stamskin Top, per color ...
-  Audio-Relax-Headrest: with integrated speakers to connect to common players ...
-  Decor surfaces our collection, (White and wenge are included in the table price) ...
-  Foot switch memory function: for controlling the basic functions and the memory positions ...

Accessories (see also page 252)

- Dentalax neck rest, synthetic leather ...
- Dentalax neck rest, PU ...
- Terrycloth (white, macchiato, or choco) ...
- Foot protective cover, PVC, transparent ...

Genusssdorf Gmachl Bergheim, Austria





Photos: © Günter Standl



SPL series



SPL series

If you are looking for a solid treatment bed, our "SPL" and "SPL Soft" are just right for you. With their four actuators, the two bed models can be adjusted as quickly as you want: From starting position to the classic treatment position, to the massage position, you can save up to eight different settings and retrieve them simply by pressing a button. With the "Standard" and "Soft" upholstery versions, the two beds offer different degrees of firmness especially for your treatments. Fold-down armrests as well as a lower bed access height make it easier for shorter customers to step up. At the same time, the pull-out headrest and footrest offer taller people optimal comfort. The seat surface rotates thanks to the optional Rotonde function. This gives you even more flexibility when working. You can choose the color of the bed upholstery – for the best look to match the ambience of your workspace – from our large PU and synthetic leather collection. The SPL is also available as a Podo version.

Properties:

- Four particularly quick actuators
- Height, inclination, as well as back and leg areas are electrically adjustable.
- Fold-down armrests
- Pull-out headrest and footrest
- "Airback" lordosis support system integrated into the upholstery (see page 202)
- Spline safety actuators to avoid the danger of crushing
- Optional Rotonde seat surface rotating function
- Bed surface available with Standard and Soft upholstery
- Upholstery made from PU or synthetic leather
- Standard upholstery color: White. Other colors from our color collection for an additional charge
- Multicolor upholstery also possible
- Base in white or titanium



- Height: approx. 63-100 cm
- Length: approx. 203 cm
- Width: approx. 85 cm max.
- (Recommended) lifting capacity: 300 kg
- Load capacity of the table surface: 350 kg

SPL

4-actuator



SPL with Standard upholstery



SPL with Soft upholstery



SPL series

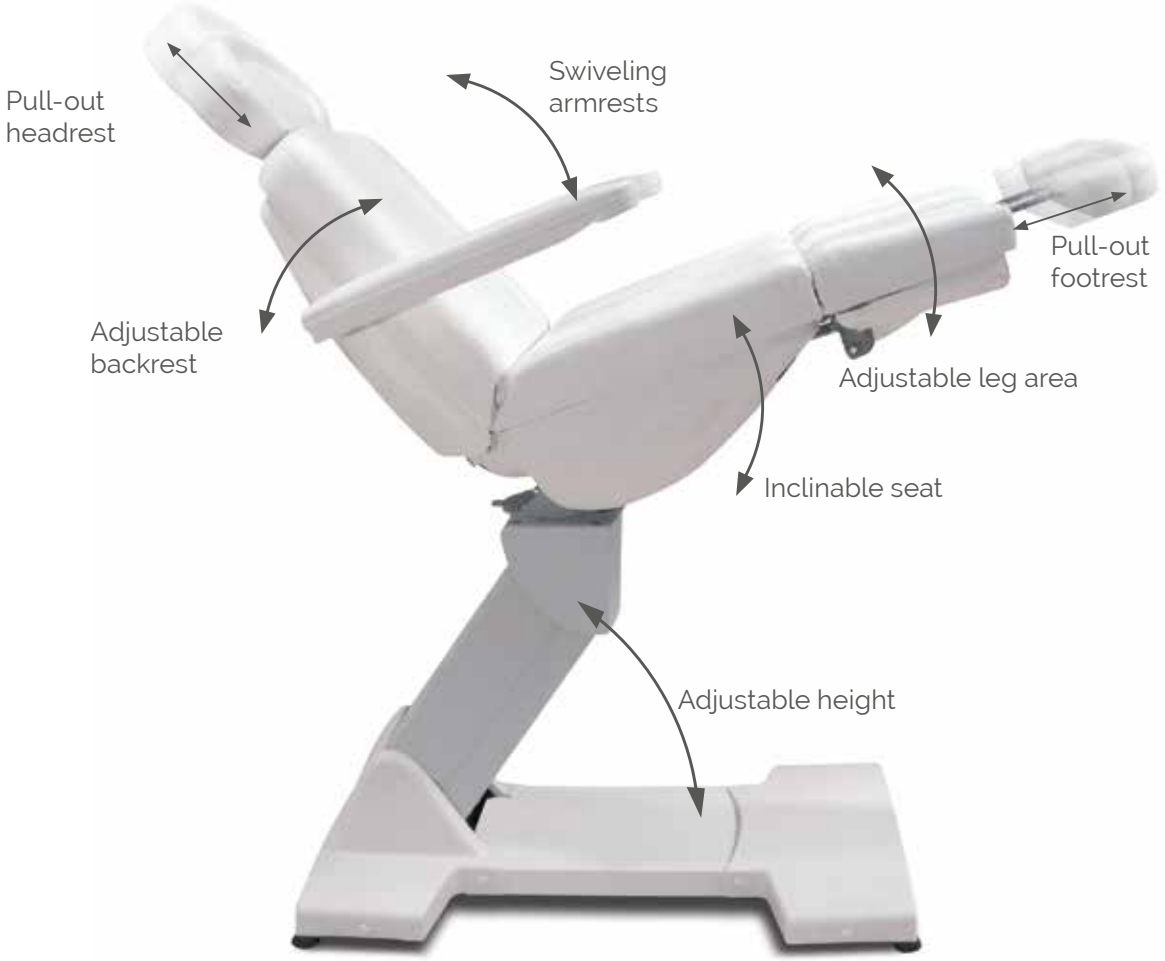

For all cosmetics treatments

The SPL and SPL Soft can be perfectly positioned for your cosmetic treatments. So you can adjust the chair height to 63-100 cm, set the backrest to 70 °, tilt the seat by 25°, and adjust the leg range from 0 to -90°. Headrest and footrest

can be extended by 10 cm and the armrests can be swiveled backwards.



Rotonde function

This feature allows the seat to be turned left or right by up to 330°. By means of the side-mounted locking it can be easily fixed in any position.



Headrest with XL extension

The adjustable and retractable XL extensions is a support surface for the arms, especially for prone body massages.



Manicure bowl

As with many other Gharieni treatment beds, the SPL also allows the installation of a detachable manicure bowl on the armrest (Exception: Soft upholstery).



Footrest

This practical chrome-plated footrest protects the plastic casing of the base from mechanical wear and tear and dirt during head-side treatments.

Options (more info. after page 20)

	Soft Upholstery	---
	Airback electrical: electro-pneumatic lordosis support system of the upholstery	---
	Smart-Thermo: programmable heating system with automatic shut-off	---
	Vibro-Wellness: gently pulsating vibration system with many adjustment options	---
	Color upholstery: max. 2 different colors PU, each color	---
	Synthetic leather standard, per color	---
	Synthetic leather Ferrari Stamskin Top, per color	---
	Synthetic leather Ferrari Stamskin One, Macchiato	---
	Logo embroidery: depending upon cost	---
	Multifunctional headrest:	
	Joint mounting, stainless steel	---
	Crescent-shaped attachment	---
	U-shaped attachment	---
	XL EXTENSION Attachment to extend the table in the upper back area	---
	Color XL Extension: max. 2 diff. colors	---
	Synthetic leather standard, per color	---
	Synthetic leather Ferrari Stamskin Top, per color	---
	Audio-Relax-Headrest: with integrated speakers to connect to common players	---
	Rotonde 330° (approx. 2 cm higher table access height): Seat rotatable by 330°	---
	Casing in titanium	---
	Castor set, brakable, Art. 73006	---
	Foot switch to control the basic functions	---

Accessories (see also page 252)

	Terrycloth (white, macchiato, or choco)	---
	Dentalax neck rest	---
	Manicure bowl + Holder	---
	Footrest	---

"Kreuz-Post" Hotel-Restaurant-Spa Vogtsburg, Germany





Photos: © Kreuz Post / Kilian



SPX series



SPX series

With their ergonomically designed upholstery and compact base, the SPX and SPX Reverse treatment beds provide optimum comfort and freedom of movement. In addition, they are suitable for almost all treatments thanks to their extraordinary design. With the memory function of the hand control, you can freely select and store eight bed positions and simply retrieve them at the push of a button. Optionally, the bed can be controlled with a foot control.

The SPX is a treatment bed with a classic bed base orientation; in the "Reverse" version, the substructure is reversed. This offers optimal freedom of movement for your legs, especially for taller treatment providers. – A small, but subtle difference that significantly improves your daily work.

Properties:

- Compact base
- Height, seat inclination, back, and leg section electrically adjustable via hand switch
- Pull-out foot and head sections
- Armrests upholstered on both sides can be folded back
- Eight freely selectable memory positions
- "Airback" lordosis support system integrated into the upholstery (see page 202)
- Spline safety actuators to avoid the danger of crushing
- Full-length ergonomic synthetic leather comfort upholstery
- Standard upholstery color: White. Other colors from our color collection for an additional charge
- Base in two versions
- Optional: Foot control



- Height: 56-92 cm
- Length: 136-204 cm
- Width without/with armrests: 62/80 cm
- (Recommended) lifting capacity: 200 kg
- Load capacity of the seat: 250 kg



SPX

4-actuator



SPX Reverse

4-actuator



SPX series



Pure versatility

The SPX can be optimally adjusted for your treatments. In addition to the adjustment of the bed height of 56-92 cm, the back section can be set to 70° and the seat as well as the foot section can be tilted by 25° or -75°. For especially tall

customers, the headrest and footrest can each be extended by 10 cm. For massage treatments, the armrests, which are upholstered on both sides, can be swiveled backwards.





Reverse version

The reversed substructure of the RLX Reverse and its compact design allow for maximum legroom in your treatments.



Ergonomic upholstery

The ergonomically-shaped upholstery offers your customers even more bed comfort. In addition, its special shell shape provides more of a "hold."

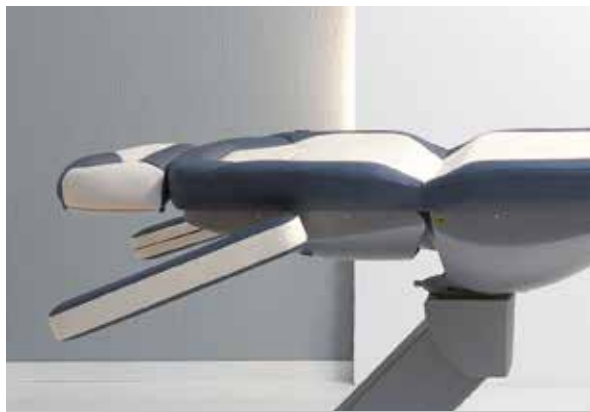

Armrests upholstered on both sides

















Particularly practical: For massage treatments, the armrests upholstered on both sides can be folded down.



Pull-out foot and head area

With its pull-out footrest and headrest, the SPX can be adapted to most body sizes. When flat, the bed can be extended up to approx. 204 cm.

Options (more info. after page 20)

-  Airback electrical: electro-pneumatic lordosis support system of the upholstery ...
-  Smart-Thermo: programmable heating system with automatic shut-off ...
-  Vibro-Wellness: gently pulsating vibration system with many adjustment options ...
-  Color upholstery: max. 2 different colors
Synthetic leather standard, per color ...
-  Synthetic leather Ferrari Stamskin Top, per color ...
-  Synthetic leather Ferrari Stamskin One, Macchiato ...
-  Logo embroidery: depending upon cost ...
-  Multifunctional headrest:
Joint mounting, stainless steel ...
-  Crescent-shaped attachment ...
-  U-shaped attachment ...
-  XL EXTENSION Attachment to extend the table in the upper back area ...
-  Color XL Extension: max. 2 diff. colors
Synthetic leather standard, per color ...
-  Synthetic leather Ferrari Stamskin Top, per color ...
-  Audio-Relax-Headrest: with integrated speakers to connect to common players ...
-  Casing in titanium ...
-  Castor set, brakable, Art. 73006 ...
-  Foot switch to control the basic functions ...

Accessories (see also page 252)

- Dentalax neck rest, synthetic leather ...
- Terrycloth (white, macchiato, or choco) ...
- Foot protective cover, PVC, transparent ...

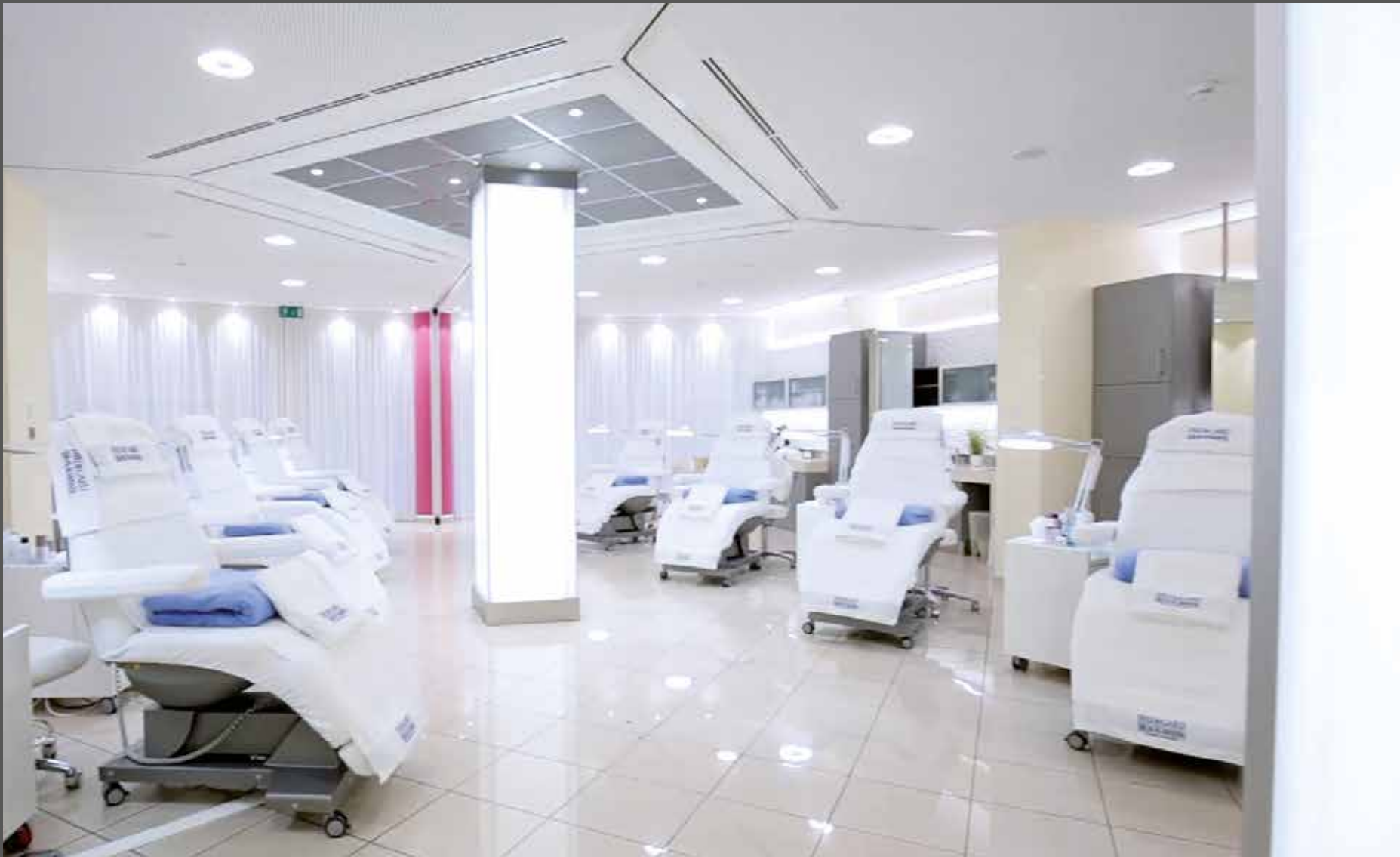

Hildegard Braukmann Burgwedel, Germany



SLXP series



SLXP series

The up to four electrical and maintenance-free low-voltage actuators of these treatment beds work quietly and are vibration-free. You can save and retrieve three personalized bed positions via the memory buttons. The ergonomically-shaped, full-length XP upholstery is quilted, breathable, and available in many different colors.

The treatment bed is available as SLXP with the classic basic orientation and as SLXP Reverse. With its "reversed" base, the Reverse offers optimal freedom of movement for the legs, especially for taller therapists – a small but subtle difference that significantly improves day-to-day work. The SLXP is also available as a Podo version.

Properties:

- Height, seat inclination, back, and leg section electrically adjustable via hand switch
- Pull-out foot and head sections
- Armrests fold backwards
- Three freely-selectable memory positions
- "Airback" lordosis support system integrated into the upholstery (see page 202)
- Spline safety actuators to avoid the danger of crushing
- Full-length ergonomic synthetic leather comfort upholstery
- Standard upholstery color: White. Other colors from our color collection for an additional charge
- Also available as a Podo version



- Height: 59-90 cm
- Length: 144-204 cm
- Width without/with armrests: 62/80 cm
- SLXP (recommended) lifting capacity: 200 kg
- Load capacity of the seat: 250 kg



SLXP

4-actuator



SPX Reverse

4-actuator

SLXP series

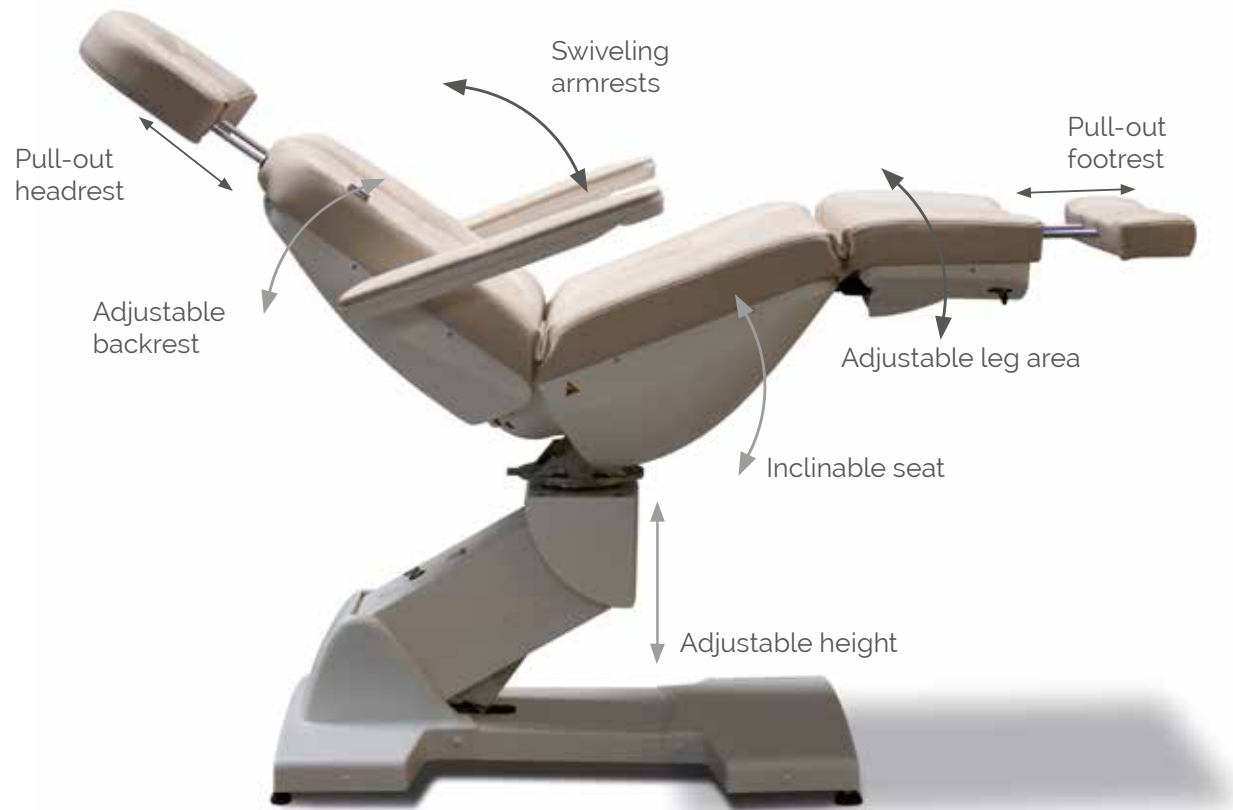

Flexible classic

In addition to the adjustment of the chair height of 59-90 cm, the back section can be raised by 70° and the seat can be tilted by 21° and the foot section by -90°. For especially

tall customers, the headrest and the footrest can each be extended by 10 cm. The upholstered armrests can be swiveled backwards for massage treatments.



Rotonde function

This feature allows the seat to be turned left or right by up to 330°. By means of the side-mounted locking it can be easily fixed in any position.



Headrest with XL extension

For massages, the XL extension provides a pleasant arm rest area for relaxed shoulder muscles. The standard headrest can be easily exchanged for the XL extension.



Footrest











The practical chrome-plated footrest protects the plastic casing of the base from mechanical wear and tear and dirt during head-side treatments. (Not compatible with the Reverse version!)



Dentalax Neck Rest

A useful accessory for a pleasant treatment: the Dentalax neck rest. It supports the position of the neck as well as the head and thus ensures maximum comfort.

Options (more info. after page 20)

	Smart-Thermo: programmable heating system with automatic shut-off	---
	Vibro-Wellness: gently pulsating vibration system with many adjustment options	---
	Color upholstery: max. 2 different colors	---
	Synthetic leather standard, per color	---
	Synthetic leather Ferrari Stamskin Top, per color	---
	Synthetic leather Ferrari Stamskin One, Macchiato	---
	Logo embroidery: depending upon cost	---
	XL extension with face cradle	---
	XL extension without face cradle	---
	Color XL Extension: max. 2 diff. colors	---
	Synthetic leather standard, per color	---
	Synthetic leather Ferrari Stamskin Top, per color	---
	Audio-Relax-Headrest: with integrated speakers to connect to common players	---
	Rotonde 330° (approx. 2 cm higher step-up height): seat rotatable by 330°	---
	Casing in titanium	---
	Castor set, brakable, Art. 73006	---

Accessories (see also page 252)

Terrycloth (white, macchiato, or choco)	---
Dentalax neck rest, synthetic leather	---
Manicure bowl + Holder	---
Footrest	---
Foot protective cover, PVC, transparent	---

Relais & Châteaux Hotel Die Sonne Frankenberg Germany



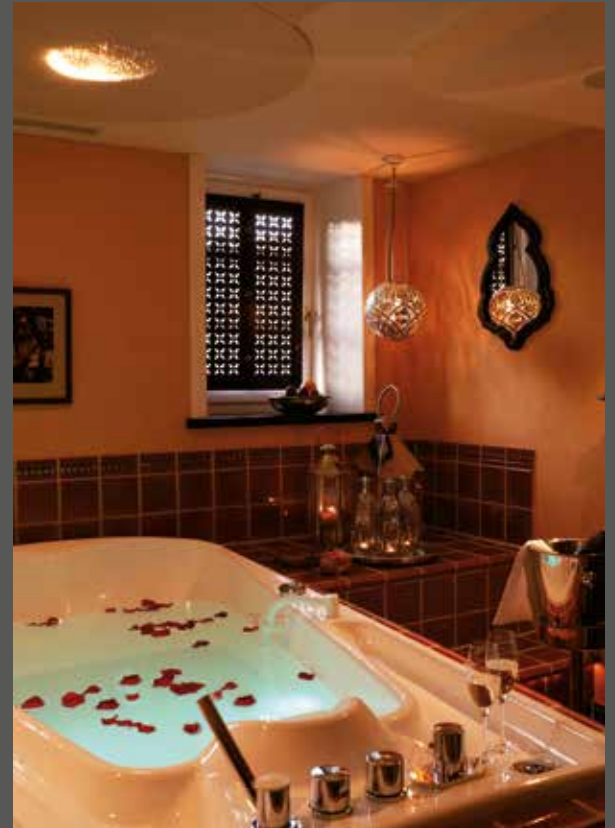

Hydraulic series



Hydraulic models

Without actuators, but with total comfort: Our hydraulic models offer almost everything their siblings with actuators can. In the case of the PLS Cos and SLXP Hydraulic, the height, seat angle, backrest, and leg section can be adjusted using a pneumatic spring without much effort. The armrests can be swiveled backward for easier starting positions for customers; and the upholstery is available in many colors.

Features:

PLS Cos Hydraulic

- Height, seat inclination, back, and leg section adjustable via pneumatic spring
- Armrests fold backwards
- Inclinable head section
- Seat rotates 360°
- Synthetic leather comfort upholstery
- Standard upholstery color: White. Other colors from our color collection for an additional charge
- Also available as a Podo version

SLXP Hydraulic

- Height, seat inclination, back, and leg section adjustable via pneumatic spring
- Armrests fold backwards
- Pull-out foot and head sections
- Seat rotates 360°
- "Airback" lordosis support system
- Full-length ergonomic synthetic leather upholstery
- Standard upholstery color: White. Other colors from our color collection for an additional charge
- Also available as a Podo version

PLS Cos Hydraulic

- Height: approx. 59-79 cm
- Length: max. 144-203 cm
- Width without/with armrest: approx. 49/68 cm
- (Recommended) lifting capacity: 300 kg
- Load capacity of the table surface: 300 kg

SLXP Hydraulic

- Height: approx. 64-83 cm
- Length: approx. 144-203 cm
- Width without/with armrest: approx. 62/83 cm
- (Recommended) lifting capacity: 300 kg
- Load capacity of the table surface: 300 kg

PLS Cos Hydraulic

With pneumatic spring



SLXP Hydraulic

With pneumatic spring

PLS Cos options (more info. after page 20)

- Color upholstery: max. 2 different colors
- Synthetic leather standard, per color
- Synthetic leather Ferrari Stamskin Top, per color
- Synthetic leather Ferrari Stamskin One, Macchiato
- Logo embroidery: depending upon cost

SLXP options (more info. after page 20)

- Color upholstery: max. 2 different colors
- Synthetic leather standard, per color
- Synthetic leather Ferrari Stamskin Top, per color
- Synthetic leather Ferrari Stamskin One, Macchiato
- Logo embroidery: depending upon cost
- XL EXTENSION Attachment to extend the table in the upper back area
- Color XL Extension: max. 2 diff. colors
- Synthetic leather standard, per color
- Synthetic leather Ferrari Stamskin Top, per color
- Casing in titanium
- Castor set, brakable, Art. 73006

Accessories (see also page 252)

- Terrycloth (white, macchiato, or choco)
- Dentalax neck rest
- Gel cushions for the face cradle
- Manicure bowl + Holder (on SLXP)
- Foot protective cover, PVC, transparent

QMS Elen, Belgium





SLR



SLR

From the classical treatment position to massage setups – as a treatment bed, the SLR is multifunctional. Equipped for four actuators, you can electrically adjust the height, back, seat inclination, and leg section via a hand switch and in addition store four memory positions. The minimal width of the back section also allows for flexible working. Thanks to its mechanically extendable castors, the SLR is also easy to move.

At 58 cm, the bed provides a low starting height; and the anatomically-shaped, one-piece synthetic leather upholstery with its mechanical Airback offers your customers optimum comfort.

The base of the SLR is available in a titanium with stainless steel elements. It comes standard with no armrests, this bed can also be optionally extended with various exchangeable and removable armrests.

Features:

- Minimal back width for flexible working
- Height, back, seat inclination, and leg section electrically adjustable via hand switch
- Hand switch
- Four storable memory positions
- Optionally, different removable armrest versions can be used
- Base in a titanium with stainless steel elements
- Low starting height
- Anatomically molded and made from one piece synthetic leather upholstery including "Airback" mechanical lumbar support system
- Standard upholstery color: White. Other colors from our color collection for an additional charge
- Mechanically extendable castors

SLR

Without armrests	---
Standard armrests	---
PU armrests	---



Without armrests



Standard armrests



PU armrests



- Starting height with inclined seat position: 48 cm
- Height: 58–85 cm
- Length: 188–210 cm
- Width without armrests: 64 cm
- (Recommended) lifting capacity: 200 kg
- Load capacity: approx. 250 kg

SLR



Suitably adjustable

The SLR can be adjusted according to your needs and those of your customers. In terms of height, the bed can be set to 58-85 cm. The seat can be inclined by 12°. The backrest can be tilted in relation to the seat from 0 to 75° and the leg sec-

tion from 0 to -80°. The headrest as well as the footrest can be extended by 10 cm. The armrests can be swiveled back and folded down for massage treatments.





Variable PU armrests

The optional PU armrests, thanks to their special design, allow for use at variable heights. They can be effortlessly removed and used on opposite sides. This results in a high or low position for resting the arms. In addition, you can also remove the armrests altogether if the treatment requires it.



Mechanically extendable castors



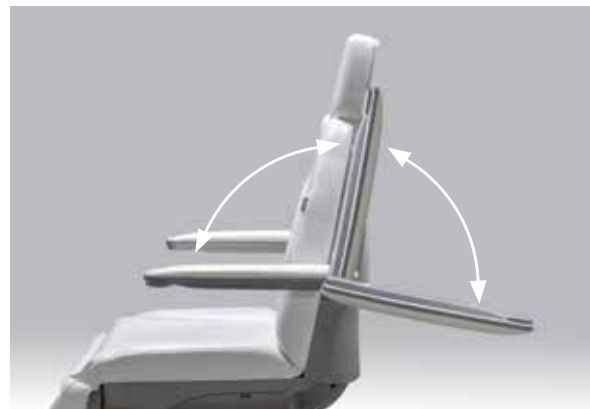





Thanks to the mechanically extendable and retractable castors, the bed can be easily moved and safely positioned.



Locking function of the armrests

The armrests can be fixed parallel to the backrest or completely folded backwards. They automatically stay there in their final position.

Options (more info. after page 20)

	Airback electrical: electro-pneumatic lordosis support system of the upholstery	---
	Smart-Thermo: programmable heating system with automatic shut-off	---
	Vibro-Wellness: gently pulsating vibration system with many adjustment options	---
	Color upholstery: max. 2 different colors	---
	Synthetic leather standard, per color	---
	Synthetic leather Ferrari Stamskin Top, per color	---
	Synthetic leather Ferrari Stamskin One, Macchiato	---
	Logo embroidery: depending upon cost	---
	Multifunctional headrest:	
	Joint mounting, stainless steel	---
	Crescent-shaped attachment	---
	U-shaped attachment	---
	XL Headrest	---
	Color XL Extension: max. 2 diff. colors	---
	Synthetic leather standard, per color	---
	Synthetic leather Ferrari Stamskin Top, per color	---
	Foot switch to control the basic functions	---

Accessories (see also page 252)

Terrycloth (white, macchiato, or choco)	---
Dentalax neck rest	---
Manicure bowl + Holder	---
Foot protective cover, PVC, transparent	---

estetica Medical Beauty and Wellness

Iserlohn, Germany





LR



LR

Height, backrest, seat tilt, and leg section of this four-actuator, column-supported treatment table can be electrically adjusted by means of a manual switch. In addition, there are four storable memory positions. The compact base ensures maximum stability, while the special shape of the back allows flexible working.

The anatomically-shaped, one-piece synthetic leather upholstery is equipped with a mechanical triple Airback for optimal comfort.

Optionally, two armrests are available for the table. These can be removed for more freedom of movement in your treatments.

The LR is also available in a Podo version.

Features:

- Minimal back width for flexible working
- Lifting column-supported treatment table
- Compact base
- Height, back, seat inclination, and leg section electrically adjustable via hand switch
- Four storable memory positions
- Optionally, various armrest versions can be used
- Removable armrests
- Anatomically-shaped and made of one piece synthetic leather upholstery
- Including mechanical "Airback" triple lordosis support system (see page 202)
- Standard upholstery color: White. Other colors from our color collection for an additional charge
- Also available as a Podo version

LR

4-actuator, without armrests ---

Standard armrests ---

PU armrests ---



Without armrests



Standard armrests



PU armrests



- Height: 56-80 cm
- Length: 151-215 cm
- Width without armrests: 61 cm
- (Recommended) lifting capacity: 250 kg
- Load capacity of the table surface: 300 kg

LR



Perfect in any position

The LR treatment bed is height-adjustable from 56 to 80 cm. The backrest can be tilted by up to 70° and the seat can be tilted by 25°. For an easy starting position, the leg area can be tilted downwards by 80°. For massage treatments,

the bed can be adjusted into a horizontal position and the ergonomically-shaped armrests can be folded backwards. In addition, the headrest and footrest can be extended by 10 cm for tall customers.





Variable PU armrests

Thanks to their special design, the optional PU armrests allow for use at variable heights. They can be effortlessly removed and used on opposite sides. This results in a high or low position for resting the arms. In addition, you can also remove the armrests altogether if the treatment requires it.



XL Extension



















The head section on the XL extension is primarily designed for prone massages. The enlarged cover surface offers additional room for resting the arms, thus creating a relaxed neck area.







Dentalax Neck Rest

A useful accessory for a pleasant treatment: the Dentalax neck rest. It supports the position of the neck and the head and thus ensures maximum comfort.

Options (more info. after page 20)

-  Triple-Airback technology: electro-pneumatic 3-zone lordosis support system of the upholstery -.-
-  Smart-Thermo: programmable heating system with automatic shut-off -.-
-  Vibro-Wellness: gently pulsating vibration system with many adjustment options -.-
-  Color upholstery: max. 2 different colors -.-
-  Synthetic leather standard, per color -.-
-  Synthetic leather Ferrari Stamskin Top, per color -.-
-  Synthetic leather Ferrari Stamskin One, Macchiato -.-
-  Logo embroidery: depending upon cost -.-
-  Multifunctional headrest: -.-
-  Joint mounting, stainless steel -.-
-  Crescent-shaped attachment -.-
-  U-shaped attachment -.-
-  XL EXTENSION Attachment to extend the table in the upper back area -.-
-  Color XL Extension: max. 2 diff. colors -.-
-  Synthetic leather standard, per color -.-
-  Synthetic leather Ferrari Stamskin Top, per color -.-
-  Electrically retractable castors -.-
-  Foot switch to control the basic functions -.-

Accessories (see also page 252)

-  Terrycloth (white, macchiato, or choco) -.-
-  Dentalax neck rest -.-
-  Gel cushions for the face cradle -.-
-  Manicure bowl + Holder -.-
-  Foot protective cover, PVC, transparent -.-

IUVENTU ANTI-AGING CLINIC

Brussels, Belgium





Photos: © Juventu Clinic

Treatment beds

Accessories



Upholstery Covers

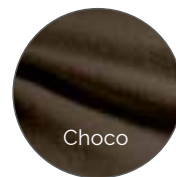
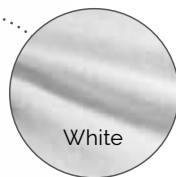

With the right covers your treatment bed will always be well protected against different types of stresses and strains. The table-specific covers are an exact match to the individual upholstery segments. With their integrated elastics, the parts of the terrycloth stay exactly where they belong, thus having no effect on the functioning of the bed.

Thanks to the high-quality material, machine washing up to 60° C is possible and therefore hygienic cleaning is possible. Our covers are available in three different colors: White, choco, and macchiato.

It is best to order the right cover directly when you buy your table. Our team would be happy to help you decide!

Dentalax Neck Rest

This little accessory supports the neck and helps to stabilize the head. This creates a more comfortable table experience while relieving the neck vertebra. We recommend the Dentalax for each of our treatment tables as an optimal supplement for the best lying comfort and an increase in treatment ergonomics. The neck rest is available to match the upholstery color of the table.

Dentalax with PU, white	---
Dentalax in PU, color	---
Dentalax with synthetic leather, white	---
Dentalax with synthetic leather, in standard colors	---
Dentalax with synthetic leather, in Stamskin colors	---



Roll holder including paper roll

The optional paper roller provides you with a practical, disposable protection for your table. This can easily be attached to the bed. As needed, the 50 cm wide paper is unrolled and pulled over the lying surface. After use tear it off at the perforation line and discard. A neat thing!

Roll holder including 1 paper roll, Art. 42064	---
Sanitary paper roll, 50 x 0.5 m, Art. 42065, up to 8 pieces, ea.	---
Sanitary paper roll, 50 x 0.5 m, Art. 42065, 9 pieces, ea.	---



Foot protective cover

To protect the table areas at the foot end, we offer a suitable protective cover made of robust, transparent PVC for all tables. It can be securely fixed to the upholstery via Velcro.

Protective cover	---
------------------	-----



Manicure bowl

Practical manicure accessories: This drip tray can be easily attached to the armrests of most Gharieni tables (with the exception of double-upholstered and PU armrests).

Manicure bowl, Art. 42020	---
Manicure bowl holder, Art. 42017	---



mikrozyd® sensitive

For the gentle and thorough care of our upholstery we recommend mikrozyd® sensitive. Available as liquid or ready-to-use cloths in a handy dispenser, it eliminates bacteria, fungi, and viruses (such as HBV, HIV, Rota, vaccinia). Without alcohol!

mikrozyd® sensitive wipes, Art. 79418	---
mikrozyd® sensitive liquid, Art. 79417	---



Neck/Knee rolls

To support a comfortable reclining position, we offer cylindrical and semi-cylindrical-shaped knee and neck rolls, each in two widths.

White, semi-cylindrical, 40 cm, Art. 42006/40	---
White, semi-cylindrical, 60 cm, Art. 42006/60	---
White, cylindrical, 40 cm, Art. 42005/40	---
White, cylindrical, 60 cm, Art. 42005/60	---

Treatment units



Spa Trolley
HST series



Spa Trolley
GST series



Treatment unit
AluVap series



Treatment unit
Twin series



Shiro Dhara
Trolley series



Treatment unit
GlaStyle



Treatment unit
Junior

Spa Trolley HST series

Spa Trolley HST

Designed as an exclusive piece of furniture, this treatment unit not only offers a storable steamer with herbal diffuser, but also an FDS, or Foam Detecting System. This serves to shut off the steamer in the event of foaming by contamination. Also particularly practical are the swiveling steamer arm, a large storage space, an extendable tray, a drawer with subdivision, as well as a Hot Cabi compartment and a magnifying lamp holder. Equipped with four low-noise lightweight castors and available in numerous decors, the HST Spa Trolley is an indispensable and perfectly integrated work unit.

Properties:

- Integrated steamer
- Swiveling steamer arm
- With herbal diffuser
- With FDS (Foam Detecting System) serves to shut off the steamer in the event of foaming by contamination.
- Pull-out tray
- Large storage space
- Drawer with subdivision
- Including Hot Cabi and magnifying lamp
- Hot Cabi compartment
- Magnifying lamp holder
- Storage compartment for Flex magnifying lamp
- Castors
- In numerous decors and different designs



Spa Trolley HST

including steamer, Hot Cabi
and magnifying lamp



HST Trolley with
storable steamer



- Height: 89 cm
- Width (closed): 50 cm
- Width (including steamer): 82 cm
- Depth (without handle): 48 cm
- Depth (including handle): 54 cm



Everything in one location

You'll see how practical the Spa Trolley is during your treatments: With its extendable tray, storage space, integrated steamer, and Hot Cabi, it has everything you need for your cosmetic treatments. Thanks to its mobility, you have everything at hand during treatment. It doesn't get any more practical!



Storable steamer

For organization in your workspace: When not in use, simply let the steamer and magnifying lamp "disappear" into the back of the spa trolley.



Integrated Hot Cabi

Best organized: A Hot Cabi is integrated into the lower compartment of the HST. This means that your warm compresses are always on hand.

Spa Trolley GST



Spa Trolley GST

Including steamer, Hot Cabi
and magnifying lamp

Spa Trolley GST

This treatment unit is exclusive and practical in the form of a trolley. This piece of furniture offers everything that makes your job easier: a storable swivel-mounted steamer, a herbal diffuser, and the Foam Detecting System (FDS) to shut down the steamer in the event of foaming by contamination. Also, the large storage space with four drawers, which can be divided in different ways according to what you want, proves itself in all treatments.

In addition, the integrated Hot Cabi offers warm towels at hand. What's more, a magnifying lamp holder and a storage compartment for the Flex magnifying lamp make the Spa Trolley GST the optimal work partner for you and in any desired location at that! Thanks to the low-noise, lightweight castors, you can easily push the Spa Trolley anywhere you need it. And last, but not least: Available in numerous decors, the Spa Trolley GST can also be perfectly integrated into any studio or workspace interior.

Properties:

- Integrated steamer with herbal diffuser
- FDS (Foam Detecting System) serves to shut off the steamer in the event of foaming by contamination.
- Swiveling steamer arm
- Large storage space
- Drawer with variable partitioning system
- Hot Cabi compartment
- Magnifying lamp holder
- Storage compartment for Flex magnifying lamp
- Castors
- In many decors
- Including Hot Cabi and lamp



- Height: approx. 117 cm
- Width (closed): approx. 70 cm
- Width (including steamer): approx. 109 cm
- Depth: 50 cm



Extensive storage space

With its numerous different drawers and compartments, the trolley offers perfect organization for any workspace.



For secure positioning

Thanks to the flexible drawer divider, the space in the drawers can be individually divided as needed. That way nothing can tip over when opening and closing drawers.



Drawer dividers

The changeable dividing interior of the drawers allows for convenient and clear organization of small instruments and preparations.



Steamer with many functions

The steamer is not only equipped with a herbal diffuser, but also with a Foam Detecting System (FDS). This shuts off foaming in the event of contamination.



Integrated steamer

As soon as you no longer need the steamer, you can stow it away in the Trolley. Simply swivel it into the appropriate storage compartment.



Practical with Hot Cabi

Thanks to the integrated Hot Cabi, warm towels and compresses are always at hand.

InterContinental Davos Switzerland





Photos: © InterContinental Davos

AluVap



- Height: approx. 100 cm
- Steamer arm reach: approx. 70 cm
- Base diameter: approx. 46 cm

AluVap

The space-saving AluVap treatment unit is your ideal partner in professional cosmetics. Made of sturdy, high-quality aluminum, it offers all the functions for modern cosmetic treatments even in the smallest of spaces. Because of its modular structure, the device configuration can be put together individually. Four modules can be integrated as needed, such as Peeling, Vac/Spray, Iono, High-frequency, and Rotating Drawer. In addition, the steamer can be expanded by an aroma or herbal option

Another highlight is the LED colored light option. This LED technology turns the steamer into an exclusive "face bio sauna." Depending on the color choice, the light enhances the psychological well-being of your customers. Thus, depending on your needs, it can have a relaxing, regenerating, balancing, stress-relieving, or revitalizing effect.

Additional equipment extras also include an Ultrasound and a Hot/Cold device, as well as a magnifying lamp in different versions; and a sanitary container as well as a beaker and cup holder are also available.

Available standard in white, black-brown, or with a titanium, you can also choose from more than 200 RAL colors. This perfect treatment unit can thus also be color-matched to integrate into any workspace.

Features:

- Compact construction
- Slim Rotary-shaped design
- Aluminum body
- Modular construction
- Assembled according to your needs
- Up to four modules to choose from
- Large radius of action
- Easy-to-use
- Short heating-up phase
- Swiveling steamer arm
- Water supply via funnel from above
- Easy to remove water tank
- Felt ring for aroma treatment
- Herbal diffuser (optional)
- Can be expanded with additional devices, magnifying lamp, and other accessories
- Comes standard in white, black-brown, and with a titanium
- Other colors possible for an additional charge

Configurator

The following modules can be used to create your own personal treatment unit:

Basic module

- Base including power block ---
- Wood decor base ---

AluVap steamer

- AluVap steamer ---
- Herbal option ---
- Colored light ---

Modules (choose from a total of four)

- Peeling ---
- Vac/Spray ---
- Iono ---
- High-frequency ---
- Rotating drawer ---

Additional devices

- Hot/Cold ---
- DeLuxe Plus magnifying lamp, white, Art. 41833 ---
- DeLuxe Plus magnifying lamp, titanium, Art. 41834 ---
- Adapter for magnifying lamps ---



Accessories

- Beaker and cup holder, Art. 90300 ---
- Felt rings, 10 pieces, Art. 90318 ---



For modules to choose from

Whether it's with Peeling, Vac/Spray, Iono, High-frequency, or Rotating Drawer – configure the treatment unit with up to four perfectly matching modules according to your needs.



Colored light

The optionally available colored light for the steamer head of the AluVap is the perfect addition: Depending on your choice of color, the light has a relaxing, regenerating, balancing, stress-relieving, or revitalizing effect.



Device holder

With this special holder you can place handpieces and their accessories, which you need for your treatments, near the AluVap treatment unit. – For particularly practical and efficient work.



Basic module base

The base of the basic module is equipped with braked castors and is available in metal as standard. For a particularly high-end look, you can also optionally choose from one of our numerous wood decors.

AluVap Versions:



AluVap steamer

The simplest version: The AluVap steamer without additional devices with rotating storage compartments.

AluVap with steamer, without devices --



AluVap workstation

Also without steamer, as an equipment trolley, the AluVap cuts a fine figure. With its slim design, it has the right device for every application.

AluVap with devices, without steamer --



AluVap Mini

Small, compact, and at the same time just as functional as its "big brother:" the AluVap Mini.

AluVap with steamer, without devices --

AluStyle

Based on the Rotary design of the AluVap, the devices from our treatment units are also available individually in robust aluminum housing. With their non-slip base and compact design, the AluStyle devices fit on almost all furniture items and equipment trolleys.

Features

- Robust aluminum housing
- Continuous adjustment, partly with illuminated display
- Exclusive lamp elements
- Exclusive Rotary design

Peeling AluStyle

- Including a soft 20 mm and 45 mm brush
- Including a hard 45 mm brush
- Sponge holder including ten small sponges

Vac/Spray AluStyle

- Including one round, flat, and curved ventouse and a large and small suction cup
- With two spray bottles and hose set

High-frequency AluStyle

- Including one 20 mm and 45 mm round electrode, one neck electrode, and one indirect electrode

Iono AluStyle

- Including one hand and two roller electrodes



Peeling AluStyle

Art. 91300



Vac/Spray AluStyle

Art. 91301



High-frequency AluStyle

Art. 91302



Iono AluStyle

Art. 91301

Twin



Twin
[see configurator](#)



Twin with Ayurveda attachment
[see configurator](#)

Twin

Elegant and stable, this metal treatment unit offers optimal flexibility for all facial treatments. Configure your Twin with up to four perfectly integrating modules according to your needs. You can choose from Peeling, Vac/Spray, Iono, High-frequency, and Rotating Drawer.

What's more, the AluVap steamer can optionally be equipped with an herbal option as well as with colored light. In addition, the Twin can be extended by a magnifying lamp and a Hot/Cold device; and up to three trays provide ample storage space.

Alternatively, the Twin can also be equipped with a Shiro Dhara attachment for ayurvedic oil forehead pouring. This makes it the perfect treatment unit for deep mental, spiritual, and physical relaxation.

Properties:

- Flexible unit versions
- Steamer body made from stable aluminum
- Modular construction
- Assembled according to your needs
- Choose from up to four device modules
- Glass or wood decor storage shelves
- Up to three trays
- Optionally with Shiro Dhara attachment
- Can be expanded with devices, magnifying lamp, and other accessories
- Steamer features: See AluVap (page 262)



- Twin height: approx. 100 cm
- Height incl. Ayurveda attachment: 178 cm
- Width: approx. 69 cm
- Depth: approx. 49 cm
- Steamer arm reach: approx. 70 cm

Configurator

The following modules can be used to create your own personal treatment unit:

Basic module

Twin Trolley including power block	---
Tray (glass or wenge decor)	---

AluVap steamer

AluVap steamer	---
Herbal option	---
Colored light	---

Modules (choose from a total of four)

Peeling	---
Vac/Spray	---
Iono	---
High-frequency	---
Rotating drawer	---

Additional devices

Hot/Cold	---
Shiro Dhara attachment	---
DeLuxe Plus magnifying lamp, white, Art. 41833	---
DeLuxe Plus magnifying lamp, titanium, Art. 41834	---
Adapter for magnifying lamps	---

Accessories

Sanitary container with holder	---
Beaker and cup holder, Art. 90300	---
Felt rings, 10 pieces, Art. 90318	---



Work tools as modules

Up to four of the Peeling, Vac/Spray, Iono, High-frequency, or Rotating Drawer modules can be perfectly integrated in the AluVap steamer. For the features of the AluVap see page 262



Colored light option

Complete the steamer with soothing colored light. Depending on the color, the light has a stress-reducing, relaxing, regenerating, balancing, or vitalizing effect.



Device holder

With this special holder, you have everything you need for your treatments at hand – whether it's brush attachments, electrodes, or ventouses. Even so, the twin is the optimal treatment unit

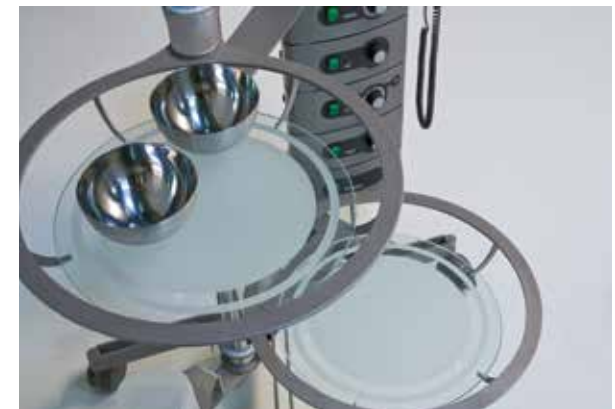

Choice of trays

With up to three height-adjustable trays, the Twin offers plenty of storage space. And for a custom look, the trays are available in glass or wood decor.

Shiro Dhara series



Shiro Dhara Trolley Wood
in black-brown ---
in chrome ---



Shiro Dhara Trolley Junior
in chrome/titanium ---

Shiro Dhara Trolley series

There are two models available for deep relaxing ayurvedic oil forehead pouring:

The Shiro Dhara Trolley Wood with a base featuring wood decor is equipped with a tray for various collection containers and an oil drainage device with collection glass. These elements are height adjustable.

On the Shiro Dhara Trolley Junior, the forehead pouring bowl has an adjustable valve. The arm and (on request several) trays are height adjustable; and the tray bottoms can be selected in wenge, glass, or wood.

Features

Shiro Dhara Trolley Wood:

- Base in wood decor
- With tray and oil drainage device including collection glass
- Different collection containers available
- Height-adjustable elements
- Castors
- Available in chrome colors and black-brown

Shiro Dhara Trolley Junior:

- For oil forehead pouring
- Trays and arm height adjustable
- Choose from glass or wenge wood for tray bottoms
- Forehead pouring bowl with adjustable valve and suspension device
- Expandable with two additional trays
- Brakable castors
- Available in chrome and black-brown

Accessories

Additional tray in glass or wood decor including holder



- Height: approx. 178 cm
- Wood base width: approx. 55 cm
- Junior base width: approx. 70 cm



Elegant forehead pouring bowl

The forehead pouring bowl of the Shiro Dhara Trolley Junior is equipped with an adjustable valve. This makes it easy to regulate the flow rate. The holder for the forehead pouring bowl is height adjustable.



Oil collection device

The Shiro Dhara Trolley Wood includes an oil drainage device with collection glass... This makes it easy to collect and dispose of the returning oil – for convenient and clean work.



Oil bowl

The Shiro Dhara trolley collects the returning oil in a stainless steel bowl. The tray for the bowl is height adjustable and can be optionally equipped with glass or wood decor bottom.

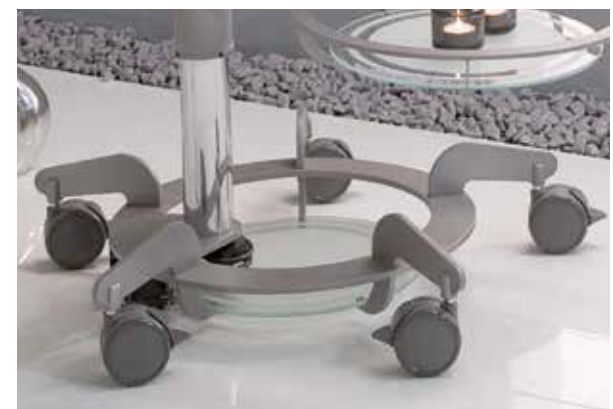

Easy-rolling castors

The five lightweight castors of the Shiro-Dhara-Wood and Junior models ensure perfect mobility and stability. This way you can easily move the trolley anywhere you need it.

GlaStyle



GlaStyle

Treatment unit

[see configurator](#)

GlaStyle

This elegant treatment unit with white or titanium-colored base leaves nothing to be desired in terms of configuration. For example, the GlaStyle can be equipped not only with up to four device modules, but also with a steamer, a Hot/Cold device, and the DeLuxe Plus magnifying lamp. Up to three glass trays also ensure sufficient storage space. Select from the following options for the rotatable device modules: Peeling, Vac/Spray, Iono, and High-frequency. In addition, you can expand the steamer that also rotates to include colored light and a herbal option. As accessories, sanitary container with holder as well as a beaker and cup holder round out this extremely practical treatment unit.

Features:

- Your choice of steamer configuration and device modules
- Choose from up to three glass trays
- Rotatable devices and steamer
- Can be expanded with magnifying lamp and devices
- Base in white or titanium
- Four brakable lightweight castors
- Steamer features: See AluVap (page 262)



- Height: approx. 96 cm
- Width (closed): approx. 50 cm
- Length: approx. 70 cm

Configurator

The following modules can be used to create your own personal treatment unit:

Basic module

Base in white or titanium	---
Glass tray	---

AluVap steamer

AluVap steamer including arm	---
Herbal option	---
Colored light	---

Modules (choose from a total of 4)

Power block including arm	---
Peeling	---
Vac/Spray	---
Iono	---
High-frequency	---

Additional devices

Hot/Cold	---
DeLuxe Plus magnifying lamp, white, Art. 41833	---
DeLuxe Plus magnifying lamp, titanium, Art. 41834	---
Adapter for magnifying lamps	---

Accessories

Sanitary container with holder	---
Beaker and cup holder, Art. 90300	---
Felt rings, 10 pieces, Art. 90318	---



Your choice of device modules

Up to four device modules entirely of your choosing can be perfectly and in a rotating fashion integrated into the GlaStyle. In this case the power block is obligatory. It supplies the device modules with the necessary power.



Two base versions

The GlaStyle base is available in both white and titanium. The brakable lightweight castors ensure smooth and silent mobility on every type of ground.



Attractive glass trays

Up to three glass trays provide sufficient storage space for your treatments. The stainless steel railing ensures that your work instruments and care products will stay where they belong.



Sanitary container

Small but excellent: This small sanitary container with its practical swiveling lid and own holder is perfectly suited for disposal of used items such as cotton pads, facial tissues, among others.

AluVap Junior

AluVap Junior

Height adjustable, easy to fill with a funnel, with a removable water tank made of glass, and a rotatable steamer head, the AluVap Junior Trolley allows for perfect, practical work. The modular assembly of the treatment unit is equipped with a steamer housing made from high-end aluminum and a storage area in the base. It can be expanded by up to three glass or wood decor trays as well as the DeLuxePlus magnifying lamp and an adapter for magnifying lamps. With the AluVap Junior with stand, we also offer a simpler version of the steamer.

Features:

- Aluminum steamer housing
- Modular composition
- Steamer height-adjustable
- Rotatable steamer head
- With up to three trays
- Glass or wood decor trays
- Easily fillable via funnel
- Removable glass water tank
- Attachment for felt rings
- Additional shelf in the base
- Also available as a simple steamer with stand



Aluvap Junior Trolley

Treatment unit

[see configurator](#)



Aluvap Junior

Steamer with stand

Aluvap Junior

- Height including steamer: max. 148 cm
- Steamer reach: approx. 65 cm
- Base diameter: approx. 65 cm



Aluvap Junior Trolley

- Height including steamer: max. 144 cm
- Steamer reach: approx. 76 cm
- Base diameter: approx. 70 cm

Configurator

The following modules can be used to create your own personal treatment unit:

Basic module

Base in titanium/chrome ---

Glass or wood tray with bracket ---

AluVap steamer

AluVap Junior steamer including arm ---

Additional devices

DeLuxe Plus magnifying lamp, white, Art. 41833 ---

DeLuxe Plus magnifying lamp, titanium, Art. 41834 ---

Adapter for magnifying lamps ---



Glass or wood trays

The up to three height-adjustable trays with railing can be selected in glass or with a wood decor. They offer a practical storage space during your treatments.

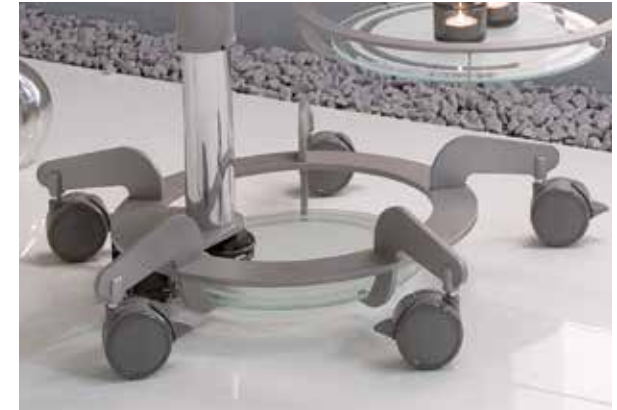

Stable base with castors

Equipped with five brakable lightweight castors, the AluVap Junior is mobile and at the same time stable and secured from falling over.



Steamer arm with rotating head

The compact, height-adjustable steamer has a rotatable head, a filling funnel, and a removable glass water tank.



Magnifying lamp holder

The magnifying lamp holder allows the corresponding adapter to attach to different magnifying lamp models. Magnifying lamps can be found in our "Medical, Feet and Care" catalog.

Accessories

Felt rings, 10 pieces, Art. 90318 ---

Additional tray in glass or wood decor including holder ---

Hotel Kaiserblick Ellmau Austria





Furnishings

Furniture series



K8



K9



K10

Equipment trolley series



MLX
Trolley



MO
Trolley



Square
Trolley



EasyStore



TK Trolley



TK Trolley

Manicure tables



Mano



Cube Square



Cube Select

Stools + Chairs



GL



Cube



Vario



GlaStyle



Pedicart



Lamica

K8 Furniture series



K8 Sideboards

The K8 series provides aesthetic design for your treatment cubicle; because the elements of this modular system are enclosed by a joint-free frame. According to your needs and the size of your workspace, the basic frame module is available in four versions: for one, two, three, or four individually assembled built-in modules in a width of 107 to 207 cm. With the built-in elements – a drawer, cabinet, and floor unit module – you can also choose according to your needs.

Features:

- In four widths: up to four modules
- Individually assembled built-in modules
- Frame available in three decors: White, Joplin, and Sinatra
- Front in white
- Also as a washbasin cabinet version
- Additional attachment basin possible
- Optionally with LED lighting



K8 Sideboard with 1 module

Without lighting	---
With lighting	---



K8 Sideboard with 2 modules

Without lighting	---
With lighting	---



K8 Sideboard with 3 modules

Without lighting	---
With lighting	---



K8 Sideboard with 4 modules

Without lighting	---
With lighting	---

K8 Sideboard with 1 module

- Height: 94.5 cm
- Width: 57 cm
- Depth: 60 cm

K8 Sideboard with 2 modules

- Height: 94.5 cm
- Width: 107 cm
- Depth: 60 cm

K8 Sideboard with 3 modules

- Height: 94.5 cm
- Width: 157 cm
- Depth: 60 cm

K8 Sideboard with 4 modules

- Height: 94.5 cm
- Width: 207 cm
- Depth: 60 cm



K8 Furniture series



Optional LED bar

The integrated LED bar provides sophisticated lighting along the upper frame surface.



For perfect organization

For easy disposal of used textiles, the drawer of the K8 laundry module can be equipped with a removable laundry basket.

K8 frame:



K8 frame for 1 module

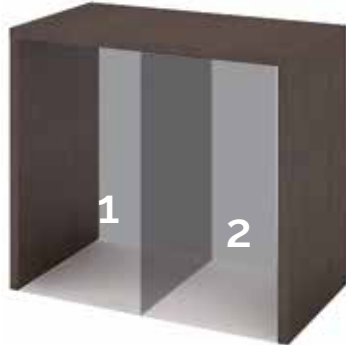

K8 frame for 2 modules

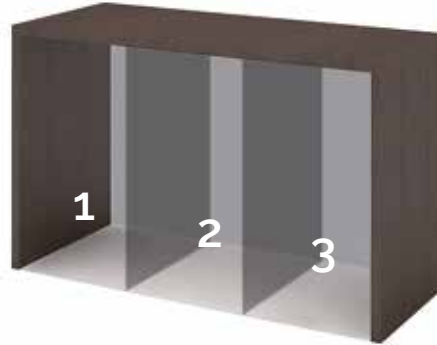

K8 frame for 3 modules

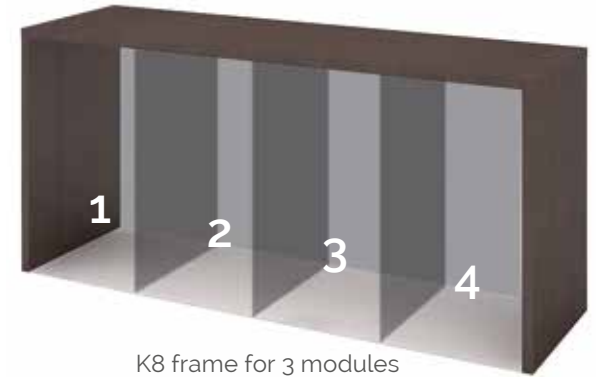

K8 frame for 3 modules

K8 built-in modules



K8 drawer module



K8 laundry module



K8 floor unit module



Basin, round
Including fittings



Basin, rectangular
Including fittings



Organizer, gray



Waster container, 11 l



Laundry basket



Organizer, white



Waster container, 5 l



Waster container, 11 l



Waster container, 5 l



Laundry basket

Kg Furniture series



Kg washbasin cabinet
With three compartments



Kg Laundry Trolley
On castors



Kg Cosmetic Trolley
On castors

K9 Furniture series

The flexible K9 furniture series meets the highest aesthetic and functional requirements. The K9 cosmetics trolley offers four spacious drawers and thus enough space for your practical work. The modern tip-on technology facilitates the use of the trolley: With light pressure, the drawers slide out gently and quietly. The elegant handle and smooth-running castors make it easy to slide the trolley into the needed position.

The exclusive K9 laundry cart offers the ideal solution for dirty laundry. Used towels, covers, and other textiles disappear immediately through the opening at the front. Like the cosmetics trolley, the position of the laundry trolley can also be adjusted by smooth-running castors.

The K9 washbasin cabinet is just as elegant as it is practical. Divided into three areas, there's plenty of space for equipment, towels, used textiles, and more. On request, an attachment washbasin can be integrated.

And for just the right look, choose from over 50 wood and color decors in matt or high gloss!

K9 washbasin cabinet features:

- Individually assembled
- Three sections for towels, various devices, used laundry, and much more.
- Additional attachment basin possible

K9 Cosmetic Trolley features:

- Four spacious drawers
- Gentle sliding out of the drawers via "Tip-On-Automatic"
- Elegant handle for moving the furniture
- Rubber castors for pushing

K9 Laundry Trolley features:

- Easy disposal of used laundry through wide insertion slot
- Laundry easily removable via large front flap
- Drawer with Tip-On-Technology
- Rubber castors for pushing



Attachment washbasin

The attachment washbasin is optionally available and makes the washbasin cabinet an optimally practical unit. For the current collection of attachment washbasins, ask our staff.



Compartment for dirty laundry

Towels, covers, and other textiles can be stowed immediately after use via the large slot of this fold-out compartment. This way your workspace will always look tidy even during treatment.



Hot Cabi

For a clean look in your workspace: Just let your Hot Cabi "disappear" into the K9 washbasin cabinet! Find out about our range of matching Hot Cabis in our "Medical, Feet & Care" catalog.



K9 washbasin cabinet

- Height: 77 cm
- Width: 176.5 cm
- Depth: 50 cm

K9 Cosmetic Trolley

- Height: 81.5 cm
- Width: 66 cm
- Depth: 43 cm

K9 Laundry Trolley

- Height: 81.5 cm
- Width: 66 cm
- Depth: 43 cm

K10 Furniture series



K10 Sideboards

The K10 furniture series is the innovative development of the successful K9 series. As a modular system with a frame that can include up to four built-in modules, the K10 series offers perfect, aesthetic organization for your workspace. According to your needs, you can assemble your K10 Sideboard from the following modules: a drawer, cabinet, and floor unit module. The Spa Trolley HST treatment unit K10 module, which can be perfectly integrated, is particularly practical. This module on noiseless lightweight castors can be easily pulled out for treatment and then pushed back into the unit.

Features:

- In three versions: with two, three, or four modules
- Individually assembled built-in modules
- Choose from various wood and color decors
- Also as a washbasin cabinet version
- Additional attachment basin possible



K10 Sideboard

With 4 modules



K10 Sideboard

With 2 modules



K10 Sideboard

With 3 modules

K10 Sideboard with 4 modules

- Height: 93 cm
- Width: 207 cm
- Depth: 60 cm



K10 Sideboard with 3 modules

- Height: 93 cm
- Width: 157 cm
- Depth: 60 cm

K10 Sideboard with 2 modules

- Height: 93 cm
- Width: 107 cm
- Depth: 60 cm

K10 Furniture series



Spa-Trolley HST



Equipment-Trolley HST

Trolley-HST modules for K10 furniture

These modules are available in two versions: As a Spa-Trolley HST with retractable steamer and Hot Cabi for your treatments (see page 256), as well as Equipment Trolley with Hot Cabi and drawers for practical storage space.



Spa & Equipment-Trolley HST

The treatment trolleys can be easily inserted under the frame when not in use and thus form a solid unit with it.

K10 frames:



K10 frame for 4 modules



K10 frame for 3 modules



K10 frame for 2 modules



K10 Built-in modules (permanently installed):

K10 Drawer modules



K10 Cabinet modules



K10 Trolley modules (pull-out, on castors):

K10 Drawer Trolleys



K10 Equipment-Trolley HST with integrated Hot Cabi



K10 Spa-Trolley HST with integrated steamer and Hot Cabi



K10 handles:

Choose the right handle for your K10 furniture! There are four different models available for this purpose – recessed shell handles, an attached bar handle, or attached bow handles made of metal or with leather insert.



Shell handle

- Recessed handle
- Aluminum
- Chrome-plated, matte

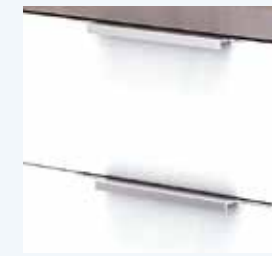

Bar handle

- Attached bar handle
- Zinc die-casting
- Aluminum-colored

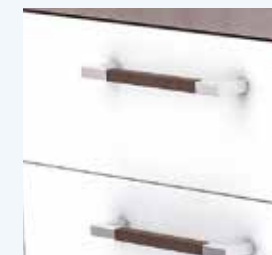

Furniture handle leather

- Attached handle strip
- Zinc die-casting chrome-plated, matte
- Lining: Leather



Furniture handle stainless steel

- Attached handle strip
- Stainless steel
- Brushed matte

K10 Furniture series



K10 Presentation Showcase

Including LED lighting ---

Individual logo ---



K10 Presentation Wall

Including LED lighting ---

K10 Presentation Showcase

With the refined and discreetly illuminated showcase with glass cover, for example, you can show your premium products "in the right light" in an appealing and classy fashion. And for your very own personalized look, the logo of your institute can be featured on the front of the showcase.

Features:

- Glass cover to protect the products
- Pull-out tray
- High-end bi-color design
- Choose from various wood and color decors
- Including illuminated frame
- Enough room for your personalized logo on the front side

K10 Presentation Wall

Put your goods in the spotlight with the K10 Presentation Wall. The modern, purist appearance of the Wall in an individual wood decor or a color surface of your choice, together with the subtly refined illumination is absolutely high-end and allows for a perfectly professional presentation of your products.

Features:

- Three shelves
- Including backlight illumination for discreet lighting
- Exclusive bi-color design or monochrome
- Choose from various wood and color decors



K10 Presentation Showcase

- Height: 116 cm
- Width: 40 cm
- Depth: 40 cm

K10 Presentation Wall

- Height: 230 cm
- Width: 160 cm
- Shelf depth: 40 cm

K10 Reception Counters

First impressions count! Therefore, welcome your customers right in your entrance area with a visual highlight. Our K10 Reception Counters offer everything you need: ample storage space for everything you need at reception and plenty of additional storage space. In addition, a subtle illumination of the front frame and a personal branding on the large front surface are possible. With an individual wood decor or color surface and the two selectable sizes, the K10 Counters fit in almost every reception area.

Properties:

- Available in two sizes
- Various drawers and compartments for keyboard, computer, and materials
- Exclusive bi-color design
- Choose from various wood and color decors
- Illuminated frame on the front
- Enough room for your personalized logo on the front side

K10 Reception Counter, small

Including LED lighting -.-

Individual logo -.-



K10 Reception Counter, large

Including LED lighting -.-

Individual logo -.-



K10 Reception Counter, small

- Height: 90 cm
- Width: 120 cm
- Depth: 70 cm

K10 Reception Counter, large

- Height: 90 cm
- Width: 160 cm
- Depth: 70 cm



Seehotel Waldstätterhof Brunnen, Switzerland





Photos: © Seehotel Waldstätterhof



MLX Trolley series



MLX Trolley versions

No matter for what purpose: Choose your suitable MLX Trolley from our offering!



Large (Height: approx. 99 cm)

Medium (Height: approx. 88 cm)

Small (Height: approx. 77 cm)

Mini (Height: approx. 55 cm)

MLX Trolley

Do you love to work when things are "tidied up" and are organization and clarity a must for you in your workspace? Then the multifunctional MLX Trolley is just right for you! With the multifunctional trolley with its variety of versions, you're guaranteed to find the right model. Whether you opt for a small, medium, or large Trolley, combine low and high Tip-On drawers, as it best suits you. Practical, too: With the all-round handle and the high-quality lightweight castors, the trolley can be moved effortlessly. In addition, it can be equipped with a magnifying lamp holder on request. Also: Thanks to the possibility of choosing from a variety of matte and glossy color and wood decors, the trolley is a perfect fit in every workspace!

Features:

- Multifunctional trolley
- Combination of high and low Tip-On drawers
- All-round handle
- Choose from a large variety of versions and designs
- High-quality castors
- Optionally with magnifying lamp holder

Accessories

Tray attachment	---
Magnifying lamp adapter, integrated, Art. 41812	---
Magnifying lamp adapter, side assembly, Art. 41804	---



- Height: 76.5 cm (small), 88 cm (medium), 99 cm (large)
- Width without handle: 45 cm
- Width including handle: 54 cm
- Depth without handle: 45 cm
- Depth including handle: 54 cm



Tip-On drawers

Just tap it a little bit: The Tip-On technology allows you to effortlessly open the drawers.



Tray attachment

Everything at hand with the optional detachable tray attachment. This allows you to provide the necessary products for your treatments and at the same time use the tray as a storage surface.



Railing

With its all-round handle in a look of your choice, the MLX Trolley is "at hand" in the truest sense of the word from all sides. In this way, it can be pushed anywhere where you need it.



Magnifying lamp holder

Optionally, the MLX Trolley can also be equipped with a holder for a magnifying lamp. In this way your "mobile storage space" offers the possibility of the right lighting for your treatments at the same time.

MLX Trolley series



MLX Display Trolley Plus
 Including Hot Cabi Maxi ---
 Display lighting ---



MLX Display Trolley
 Without Hot Cabi ---
 Display lighting ---

MLX Display Trolley

The MLX Display Trolley features side compartments with flap, a fold-out compartment, and a drawer in the front area as well as a Hot Cabi compartment for optimal storage space.

With an optional illuminated display, you can also perfectly present your preparations. Of course, you can also choose your decor from a variety of colors and textures to suit your taste in these elegant designer pieces. The Display Trolley is available in two versions: narrow and as a wider Plus version including a Hot Cabi.

Features:

- Fold-out compartment and drawer in the front area
- Side compartments
- Optional illuminated display for attractive placement of your preparations
- Available in different decors
- Lightweight castors
- All-round handle

Accessories

- Tray attachment ---
- Magnifying lamp adapter, integrated, Art. 41812 ---
- Magnifying lamp adapter, side assembly, Art. 41804 ---

MLX Display Trolley

- Height: 99 cm
- Width (without handle): 45 cm
- Width (including handle): 54 cm
- Depth (without handle): 45 cm
- Depth (including handle): 54 cm



MLX Display Trolley Plus

- Height: 99 cm
- Width (without handle): 50.5 cm
- Width (including handle): 60 cm
- Depth (without handle): 52 cm
- Depth (including handle): 62 cm



Hot Cabi

The wider display Trolley Plus has a standard integrated Hot Cabi. This way your warm compresses are always at hand.



Side storage compartments

For practical working: Reachable from both sides, the side storage compartments offer quick access. With the Display Trolley Plus, the storage compartments can also be closed with a flap.



Lighting display

For optimal product presentation and a sophisticated appearance, the base plate can be equipped with lighting.



Tip On

A light press is all it takes: Thanks to the Tip-On technology, the drawers open effortlessly and quietly.

MLX Trolley series



MLX Wax Trolley
Including wax heater ---



MLX Wax Trolley Plus
Including 1 wax heater ---
Including 2 wax heaters ---

MLX Wax Trolleys

The flexible MLX Wax Trolleys with lightweight castors offer simple and clean depilating: In the upper compartment there is an integrated wax heater and recesses for wax cans. The integrated folding waste container allows for easy disposal. The full-length storage compartment in the back area permits access from both sides. The MLX Wax Trolley Plus can also store a supply of three wax pistols in the middle drawer. The Trolleys are available in various decors.

Features:

- With integrated wax heater
- Optional second wax heater possible
- Extendable compartment e.g for wax pistols on the MLX Wax Trolley Plus
- Cover can be pushed back and used as a storage area
- Side storage compartments
- Practical folding waste container
- Available in different decors
- On castors

Accessories

Magnifying lamp adapter, side assembly, Art. 41804



- Height: 99 cm
- Width without handle: 45 cm
- Width including handle: 54 cm
- Depth (without handle): 45 cm
- Depth (including handle): 54 cm



Practical cover

The wax heater integrated in the upper compartment and the wax can recesses are covered by a sliding plate. When opened, this can be used as a practical storage space.



Drawer for wax pistols

In its extendable middle drawer, the MLX Wax Trolley Plus offers the possibility to accommodate three wax pistols.



Integrated hinged waste container

The integrated hinged waste container in the MLX Wax Trolley makes it easy to dispose of your consumables.



Side storage compartments

For practical working: Reachable from both sides, the side storage compartments offer quick access.

MO Trolley



MO Trolley
Including 4 insert baskets

MO Trolley

Our MO Trolley provides clear design and lots of storage space with its spacious drawer and the large storage baskets. Thanks to its invisible castors, the Trolley can be positioned anywhere it is needed. With its different wood and color decors, it not only fits into any ambience, but thanks to its design, also perfectly matches our MO1 spa tables.

Properties:

- Mobile trolley
- Compact, low construction
- With a spacious drawer
- Pull-out shelf for devices or preparations
- Drawers with soft-close technology
- Sturdy metal baskets for secure storage
- Available in different decors
- Lightweight, invisible castors

Accessories

Magnifying lamp adapter, side assembly, Art. 41804

--



Stable storage baskets

The aluminum baskets specially made for the MO Trolley ensure safe storage; Rubber feet effectively prevent slipping. When not in use and during cleaning, the shelves can be easily removed.



Gently closing drawers

The spacious drawers offer plenty of space for your work instruments and equipment. Also: Thanks to their Soft-close technology, the drawer and pull-out shelf close quietly and gently.



- Height: 68 cm
- Width: 61 cm
- Depth: 46 cm

Square Trolley



Square Trolley
Complete [---](#)

Square Trolley

This mobile preparation trolley is the practical helper for all your treatments. The side compartments and two drawers in the front area allow you to store everything you need. An extendable tray in the front provides a useful storage space; The folding compartment stores used materials and the side handles can be used as towel holders. Equipped with castors, the Trolley can effortlessly and quietly move to any desired place. And if the Square Trolley is to be used with a magnifying lamp, it can be optionally equipped with a magnifying lamp holder.

Features:

- Mobile preparation trolley
- Two drawers in the front area
- Drawers with Tip-On-Technology
- Side compartments
- Fold-out compartment for waste
- Handles on the sides that can be used as towel holders
- Pull-out tray
- Available in different decors
- On castors
- Optionally with magnifying lamp holder

Accessories

Magnifying lamp adapter, integrated, Art. 41812	--
Magnifying lamp adapter, side assembly, Art. 41804	--



- Height: approx. 82 cm
- Width (without handle): 45 cm
- Width (including handle): 54 cm
- Depth: 45 cm



Pull-out tray

The extendable tray offers a convenient storage area for all treatments.



Drawer with Tip-On-Technology

The drawers can be easily opened with their Tip-On-Technology with the touch of a finger.



Integrated fold-out compartment

Used materials can be disposed of immediately in the folding compartment in the front.



Side storage compartments

The side compartments accessible from both sides provide additional practical storage space.

EasyStore series



EasyStore drawer module
Including 4 drawer elements ---
Additional drawer element ---



EasyStore Shelf module
Including 4 shelves ---

EasyStore series

This elegantly designed furniture series ensures that your workspace is always tidy; and the special thing about it: The mobile cabinet elements can be equipped according to your needs. This means that you can choose from up to five drawer elements in the drawer module and use the shelves individually for the shelf module.

Thanks to their lightweight castors, the EasyStore modules can be used as mobile stand-alone furniture. If necessary, you can also combine them into a row of furniture. Available in various decors, the practical furniture can also be perfectly integrated into any environment.

Properties:

- Mobile cabinet elements
- Use as mobile stand-alone furniture or connected to a row of furniture
- Flexible shelves in the shelf module
- Number of drawer elements (max. five) selectable for the drawer module
- Available in different decors
- Lightweight castors

Accessories

- Magnifying lamp adapter, integrated, Art. 41812 ---
- Magnifying lamp adapter, side assembly, Art. 41804 ---



Modular construction

The mobile cabinet elements can be equipped with up to five drawer modules or with flexible shelves. In addition, the drawer and shelf modules can be put together to form a furniture row.



Enclosed storage area

The elegant metal edge of the shelf ensures that your products are secure.



- Height: 99 cm (with 4 drawers)
- Width: 40 cm
- Depth: 57 cm

TK Laundry Trolley



TK Laundry Trolley
With or without castors

TK Laundry Trolley

Elegant, functional, and mobile – the TK Laundry Trolley has everything a modern laundry trolley needs. A practical laundry flap makes towels disappear with a flick of the wrist. In addition, the Trolley includes a pull-out laundry compartment and three shelves. And typical of Gharieni: The Laundry Trolley is of course also available without castors. Suitable for every interior there are the fronts in different wood tones.

Features:

- Mobile laundry trolley
- Modern design
- Practical laundry flap
- Pull-out laundry compartment
- Three shelves
- Metal frame
- Fronts in different wood tones
- With or without castors



Laundry compartment

A container for your dirty laundry easily accessible through a small flap in the right door.



Collection container

The hidden laundry container can easily be pulled out. This makes it easier to remove the soiled laundry.



A lot of storage space

In addition to the laundry compartment, the spacious Trolley with its three adjustable shelves offers variable storage space for towels, products, and much more.



Optional: large brakable castors

Despite its size, the TK Laundry Trolley is easily movable with its optional lightweight castors. This allows it to be easily moved to any place.



- Height: approx. 90 cm
- Width: 110 cm
- Depth: 43 cm

TK Trolley



TK Trolley

With 3 drawers

TK Trolley

A visual highlight for your workspace and a practical helper at the same time – this is the CL Trolley mobile preparation trolley. Extraordinarily designed in its shape and in a modern semi-metal look, it offers everything that makes work simple: There is plenty of room for your products in the compartments of the semicircular front; and three rear-facing drawers guarantee clarity and quick access to everything you need for your treatments. You can also dispense individual facial tissues very practically from a special device. Equipped with a railing and pleasantly quiet lightweight castors, the preparation trolley can be easily transported wherever you need it. And of course you can choose "your" CL Trolley from a variety of decors to match your workspace equipment.

Properties:

- Mobile preparation trolley in modern semi-metal look
- Recessed storage surface for preparations above
- Device for individually dispensing facial tissues
- Storage compartments on the front side
- Three drawers in the rear area, arranged in a terrace pattern
- Railing
- Available in different decors
- With lightweight castors

Accessories

Magnifying lamp adapter, integrated, Art. 41812

Magnifying lamp adapter, side assembly, Art. 41804



- Height: approx. 78 cm
- Width: approx. 44 cm
- Depth: approx. 67 cm



Recessed storage surface

In the recessed storage surface, products can be securely set aside during your treatments. The built-in facial tissue dispenser is also practical.



Clear & handy

Thanks to the three terraced drawers on the back of the CL Trolley, you can store everything clearly and within easy reach.



Enough space

The two compartments in the semicircular front can be used for a supply of products.

GL Trolley series



GL60 Trolley
Art. 35120



GL45 Trolley
Art. 35121



GL Square Trolley
Art. 35117

GL Trolley series

The GL Trolleys are equipped with a practical pull-out shelf for various devices and three drawers. In different sizes, it offers you the storage space that you need for tidy work. Comes standard in white or wenge, but other decors are also optionally possible. On request, the Trolley is also available with a magnifying lamp holder. Four large rubber castors, two of which are brakable, make the GL Trolley mobile.

Properties:

GL 60/45 Trolley

- Pull-out shelf for various devices
- Three drawers
- Four large rubber castors, of which two are brakable
- In white or wenge decor, additional decors optional
- Optionally with magnifying lamp holder

GL Square Trolley

- Pull-out shelf for various devices
- Three drawers
- Four large rubber castors, of which two are brakable
- In white or wenge decor, additional decors optional
- Optionally with magnifying lamp holder

Accessories

Magnifying lamp adapter, side assembly, Art. 41804

GL60 Trolley

- Height: 80 cm
- Width: 60 cm
- Depth: 40 cm



GL45 Trolley

- Height: 80 cm
- Width: 45 cm
- Depth: 40 cm

GL Square Trolley

- Height: 102 cm
- Width: 40 cm
- Depth: 42 cm



Removable storage shelf

The removable storage shelf provides space for devices or your work instruments.



Suitable for magnifying lamp

The optional magnifying lamp holder allows you to equip the trolley with the right lighting for your treatments.



Space for one Hot Cabi

The Trolley GL Square offers the possibility to integrate a Hot Cabi.

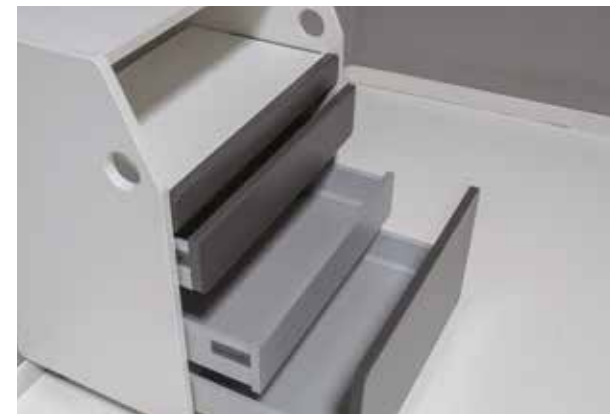

Spacious drawers

Three drawers provide ample storage space, so you can accommodate all the important things for your work.

Cube Trolley series



Cube Square Trolley

with castors	---
Without castors	---
Base in chrome, additional charge	---

Cube Square

The Cube Square Trolley, with its modern, simple design, is available in three versions: a large drawer and an internal storage compartment, with two drawers, or a drawer and a storage compartment. Particularly practical: The smaller drawers can be pulled out on both sides. The trolley is available in white, wenge, or optionally also in two colors; and the square metal base can be (optionally) selected in white, titanium, black, or chrome. For a look that fits your workspace, you can also configure the Cube Square into one of our numerous other decors.

Equipped with lightweight castors, the trolley is also perfectly mobile.

Properties:

- Modern, clear design
- Wood decor in white and wenge
- Optional two-tone
- High-end metal-wood combination
- Square metal base in white, titanium, or black-brown
- Chrome base optional
- Additional decor versions possible
- Available in three versions: With a large drawer and internal storage compartment, with two drawers, or with a drawer and a storage compartment
- Small drawers can be pulled out on both sides
- Brakable lightweight castors

Accessories

Magnifying lamp adapter, integrated, Art. 41812 ---

Magnifying lamp adapter, side assembly, Art. 41804 ---



- Height: 78.5 cm
- Width: 43.6 cm
- Depth: 46 cm



Drawers can be pulled out on both sides

A clever detail on the Cube Trolley: the drawers can be pulled out on both sides. This way you have quick access to your work instruments from all sides.



Modern design

Its wood-paint-metal look makes the Cube Square Trolley a visual highlight. Of course, it can also be configured in a monochrome design. Ask about our current wood decor palette!



Optional: Chrome base

In addition to the standard colors white, black-brown, and titanium, the base of the Cube Trolleys is also available in elegant chrome.



To go with it: the Cube Square manicure table

On page 326 in this catalog you will also find the matching manicure tables from our Cube series.

Cube Trolley series



Cube Select Trolley

- With castors ---
- Without castors ---
- Base in chrome, additional charge ---

Cube Select

With the Cube Select Trolley, you can choose between two equipment options: a large-capacity drawer and two medium-sized drawers. In the lightweight castor version, the Cube Select can be moved anywhere you need it.

With its high-end metal-wood combination – a decor in white or wenge and its round metal base in white, titanium, black-brown, or optionally in chrome – this practical trolley looks very sophisticated. Upon request, it is also available in other decor versions.

Features:

- Optionally with a large drawer and two spacious inner surfaces or with two medium-sized drawers
- High-end metal-wood combination
- Wood decor in white or wenge
- Metal base with round column in white, titanium, or black-brown
- Large lightweight castors
- Also without castors
- Optional metal base in chrome available
- Additional decor versions optional

Accessories

Magnifying lamp adapter, integrated, Art. 41812 ---

Magnifying lamp adapter, side assembly, Art. 41804 ---



- Height with castors: 74 cm
- Width: 41 cm
- Depth: 43 cm



Various drawers

With the Cube Select, you can choose between a large-capacity drawer with two spacious inner compartments or two medium-sized drawers.



Elegant metal base

The metal base with its slim, round column makes the trolley look very light. Available in white, black-brown, titanium, and chrome.

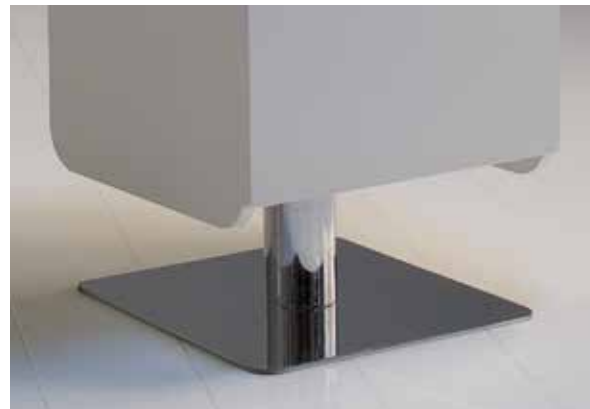

With or without castors

In addition to the large lightweight castors, the Cube Trolley can be equipped with a simple stationary stand.



Matching: Cube Manicure Table

On page 328 in this catalog you will also find the matching manicure tables from our Cube series.

Vario series



Vario Select
With doors ---
Without doors ---



Vario Square
With doors ---
Without doors ---



Vario series

The Vario Square and Vario Select trolleys offer a wide range of options for practical work in any location. The upper shelf can be swiveled to the side and the inner shelves can be mounted at different heights as required. Depending on your needs, a Hot Cabi or Hot Stone Warmer can also be optionally integrated into the Vario Square. This elegant Trolley is available standard in white or wenge wood decor. Our wide decor range also gives you the opportunity to adapt the trolley perfectly to your ambience.

Features:

- Upper shelf can be swiveled laterally
- Inner shelves can be mounted at different heights
- Installation of a Hot Cabi or Hot Stone Warmer optional
- Wood decor in white or wenge
- Metal curves in white, titanium, or black-brown
- Special equipment possible
- with lightweight castors



Sophisticated curves or classical square

Its curved metal parts give the Vario Select a particularly elegant look. However, the Vario Square appears classically straight with its angular edges. The choice is yours!



Swiveling shelves

The top compartment holds a Hot Cabi or a Hot Stone Warmer. The split cover can be swiveled sideways. This gives you access to the Hot Stone Warmer from the top.



Storage space

The shelves inside the cabinet are individually mountable. Instead of the Hot Stone Warmer, other devices such as our small Hot Cabi can be installed.



- Height: 80 cm
- Width (closed): 70 cm
- Width (with open panels): 130 cm
- Depth: 43 cm

GlaStyle



GlaStyle	
With 1 tray	:-:-
With 2 trays	:-:-
With 3 trays	:-:-

GlaStyle

An equipment trolley with an extraordinary design – that's the GlaStyle. The combination of metal and glass and its curved design make it an exceptional helper in your studio. With up to three height-adjustable and swiveling glass tops, it offers you enough storage space for everything you need for your treatments. Also practical are the integrated magnifying lamp holder and the lightweight castors. These allow you to easily move the GlaStyle to where you need it. In addition to the number of glass surfaces, you can also choose the color of the base to your liking in white or titanium.

Properties:

- Up to three swiveling shelves in glass decor with chrome-plated edging
- Height-adjustable and swiveling glass tops
- Railing can be shortened
- Base in white or titanium
- Magnifying lamp holder
- With brakable lightweight castors



Glass surfaces with railing

The glass shelves are equipped with a railing that can be shortened. This allows everything to be stored securely to prevent it from falling.



Color of your choice

You can choose the base of the trolley in white or titanium.



With magnifying lamp

Thanks to the integrated holder, you can also equip the preparation and device trolley with a magnifying lamp.



Easy to move

With its large lightweight castors, the GlaStyle is mobile and at the same time stable. In addition, the base of GlaStyle offers a practical little waste container.



- Height: 89 cm
- Width (closed): 50 cm
- Width (including steamer): 82 cm
- Depth (without handle): 48 cm
- Depth (including handle): 54 cm

Pedicart

Pedicart with a drawer and Hot Cabi compartment (without Hot Cabi)



Pedicart with three drawers



Pedicart with seat upholstery

Pedicart without seat upholstery	
With drawer and Hot Cabi compartment	---
With 3 drawers	---

Pedicart with seat upholstery	
With drawer and Hot Cabi compartment	---
With 3 drawers	---

Pedicart

This practical, compact trolley features a Tip-On drawer and a pop-up compartment for a Hot Cabi Mini with space for around six compresses. Thanks to its large, lightweight castors, you can easily push the Pedicart wherever you need it. The combination of metal and wood in white or wenge decor makes the trolley particularly elegant. Optionally, you can also choose a different decor from our wide range of options – for a look that fits perfectly with your workspace interior.

Features:

- Tip-On Drawer
- Optionally with two drawers or one drawer and Hot Cabi compartment
- Hot Cabi available separately
- High-end metal-wood combination
- Wood decor in white or wenge
- Additional decors optional
- Metal parts in titanium, white, or black-brown
- Large lightweight castors
- Optional seat upholstery in different colors



- Height without upholstery: 60 cm
- Height including upholstery: approx. 64 cm
- Width: 40 cm
- Depth: 43 cm



Seat upholstery

Optionally, the Pedicart can also be equipped with upholstery. This makes it a practical seat. The upholstery is covered with synthetic leather and available in many colors.



Tip-On-Technology

A light touch of the finger is enough – and then the Tip-On drawer opens. This technology makes a drawer handle superfluous.



Hot Cabi

The folding compartment is designed to accommodate our Hot Cabi Mini. This way you have warm compresses always at hand.



Metal-wood look

The combination of different wood decors from our current collection with white, black-brown, or titanium-colored metal looks particularly sophisticated.

Lamica Trolley series



Lamica Decor Line Trolley

- With 2 tray compartments ---
- With 3 tray compartments ---
- Drawer ---



Lamica Wood Decor Trolley

- With 2 tray compartments ---
- With 3 tray compartments ---
- Drawer ---



Lamica Glass Decor Trolley

- With 2 tray compartments ---
- With 3 tray compartments ---
- Drawer ---
- Glass drawer holder ---

Lamica Trolley

Do you need a versatile trolley in your workspace? Then the Lamica model is just right for you! Because the trolley can be customized. This way you can choose from two or three shelves as well as a drawer. In addition, it can be equipped with a sanitary container with holder.

The design can also be chosen as desired: The shelves are available with an elegant glass and wood look or in classic white. The frame is available in titanium, black-brown, or chrome; and the large lightweight castors are color-matched to it.

Properties:

- With two or three shelves
- With railing
- With or without drawer
- In a sophisticated glass and wood look or in classical white
- Frame in titanium, black-brown, or chrome-plated
- On large, color-matched lightweight castors
- Optionally with magnifying lamp holder,

Accessories

Magnifying lamp adapter, Art. 41820

Water bowl with holder, Art. 41180



Optional magnifying lamp holder

For practical work, the trolley optionally offers a holder for a magnifying lamp. In addition to your work instruments, you will always have the right lighting in your area.



Optional collection container

Used material can be stored in the stainless steel bowl attached to a holder. For best positioning, the holder can be adjusted horizontally and vertically.



Lamica Wood Decor Trolley

- Height with 2 shelves: 76 cm
- Height with 3 shelves: 94 cm
- Width: 65 cm
- Depth: 42 cm

Lamica Decor Line Trolley

- Height with 2 shelves: 76 cm
- Height with 3 shelves: 94 cm
- Width: 59,5 cm
- Depth: 42 cm

Lamica Glass Decor Trolley

- Height with 2 shelves: 79 cm
- Height with 3 shelves: 95,5 cm
- Width: 65 cm
- Depth: 42 cm



Optional drawer

On request, the Lamica can also be equipped with a drawer to match the look.

The One Barcelona Spain





Photos: © The One

Mano



Mano manicure table

Glass top in white or black



Mano

This manicure table looks particularly light and elegant with its special curved glass top. The practical drawer container with its easy-open Tip-On compartments offers space for everything you need for a manicure. And of course, the manicure table also has an integrated lamp holder.

When it comes to design, the Mano leaves nothing to be desired. Thus you can choose its glass top in white or black and the metal parts in white, titanium, or black-brown. So that the Mano optimally matches the ambience of your workspace, we have a large collection of wood decors ready for you.

Features:

- Worktop made of special curved glass
- With drawer container
- Drawers with Tip-On-Technology
- With black or white glass top
- Container available in different wood decors
- Metal elements in white, titanium, black-brown
- Integrated lamp holder (without lamp)

Accessories

Slimline LED working light, Art. 41820



- Height: 79.5 cm
- Width: 129 cm
- Depth: 57 cm



For perfect lighting

The integrated lamp holder is suitable for our Slimline LED working light. This not only ensures optimal lighting, but also a visually compelling overall appearance.



Large amount of space

With three drawers, the Mano container provides ample space for all the tools you need for a manicure.

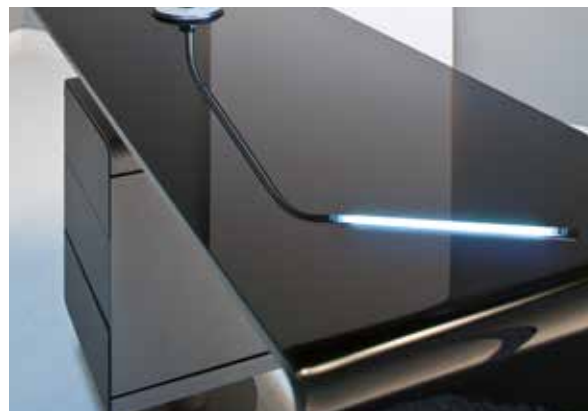

Curved glass top

The curved plate made of special glass in black or white looks light and sophisticated at the same time.



Just simply Tip-On

A slight pressure is all it takes and the drawers open quietly. As a result, no handles are needed. This creates a clean look.

Cube Square



Cube Square manicure table
With 1 container ---
Feet in chrome, additional charge ---



Cube Square Duo manicure table
With 2 containers ---
Feet in chrome, additional charge ---

Cube Square

The Cube Square manicure table is impressive with its modern, clear design. It is available in white, wenge, or optionally also in two colors; and the square metal base can be (optionally) selected in white, titanium, black, or chrome. For a harmonious look for your workspace, you can also configure the Cube Square with one of our numerous other decors.

Depending on your needs, we also offer the manicure table with one or – in the duo variant – two containers. You also have your choice of a maxi drawer and two compartments on the inside or two medium-sized drawers, all equipped with a soft-close.

Features:

- In contemporary linear design
- Drawer container on both sides or on one side
- Containers optionally with one maxi- or two medium-sized drawers with soft-close
- The maxi drawer offers two spacious compartments inside
- In white or wenge
- Additional decors optionally available
- Optional two-tone
- Angular metal elements in white, titanium, black-brown, or chrome

Cube Square manicure table

- Height: 81 cm
- Width: 125 cm
- Depth: 50 cm



Cube Square Duo manicure table

- Height: 81 cm
- Width: 154 cm
- Depth: 50 cm



Optional: Chrome base

In addition to the standard colors white, black-brown, and titanium, the bases of the Cube Square manicure table are also available in elegant chrome.



Modern design

Its look in wood, paint, and metal make the Cube Square Trolley a visual highlight. Of course, it can also be configured in a monochrome design. Ask about our current wood decor palette!



Two drawer versions

Depending on your needs, the Cube Square can be equipped with one maxi drawer or two medium drawers. The choice is yours!



Perfectly combinable

For uniform ambience, we also offer a matching trolley series with three versions. You can find more information about it on page 310.

Cube Select



Cube Select manicure table
Without suction ---
with suction ---
Metal parts in chrome ---



Cube Select Duo manicure table
Without suction ---
with suction ---
Metal parts in chrome ---

Cube Select

The Cube Select manicure table looks very sophisticated with its metal-wood combination. With a decor in white or wenge and its round metal base in white, titanium, black-brown, or chrome (optional), it integrates into any workspace ambience. Upon request, it is additionally available in other decor versions.

Choose the manicure table with one maxi or two medium-sized drawers with soft-close.

Features:

- With one or two drawer containers
- Container with one maxi or two medium-sized drawers with soft-close.
- With or without suction
- Wood decor in white or wenge
- Additional decors optionally available
- Metal elements in white, titanium, black-brown, or chrome (additional charge)



Optional suction

If you opt for the suction system embedded in the table top, you'll no longer be bothered by annoying nail dust.



Storage space upon request

When equipping the container(s), you can choose between one large-capacity drawer with two spacious inner compartments or two medium-sized drawers.



Metal parts in chrome

In addition to the standard colors white, black-brown, and titanium, the bases of the Cube manicure table are also available in elegant chrome.



Perfectly combinable

For practical working and a uniform appearance, the Cube Select manicure table can be combined with the Cube Select Trolley (see page 312).



Cube Select manicure table

- Height: 81 cm
- Width: 125 cm
- Depth: 50 cm

Cube Select Duo manicure table

- Height: 81 cm
- Width: 154 cm
- Depth: 50 cm

Four Seasons Moscow Moscow, Russia





© Herfort, Frank / Four Seasons



© Herfort, Frank / Four Seasons

Stools & Chairs



Stools & Chairs

Not only your customers should be comfortable during the treatment! In order to be able to work comfortably and efficiently, the working chair factor plays a role that is not to be underestimated. Here, the focus is on ergonomics. This includes not only a comfortable seat surface, but also optimum adjustability. Our stools and chairs offer you all these features. Find exactly the right chair to suit you and your work from our wide range of products. We also don't come up short in terms of looks. Optionally, you can configure our working chairs, in addition to the standard white, in different colors to suit your personal ambience. In addition, with our four castor base versions, we offer optimum possibilities to configure your personal working chair. Optional extras like our Floating feature and Airback-Technology round out our offering.

Features:

- Stools and chairs come standard with white upholstery (except PU stools) and black base
- Rotatable seat
- Rubber castors with Roll-Stop function
- Comfortable upholstery
- Washable and durable cover
- Synthetic leather cover optional in various colors from the current Gharieni or Ferrari Stamskin color collection (see catalog cover)
- Pneumatic height adjustment
- 5-castor safety base
- Four different castor base versions



Four stool bases to choose from

For most of our stools we offer four bases to choose from. By default, a black star with black pneumatic spring is included in the price.

Stool-Star, black, ø 60 cm	included.
Stool-Star, titanium, ø 62 cm	---
Stool-Star, chrome, ø 62 cm	---
Stool-Star, small, chrome, ø 50 cm	---



Upholstery in different colors

Our stools and chairs come standard equipped with white synthetic leather. Optionally, you can also choose a colorful cover from our current Gharieni or Ferrari Stamskin color chart (page 25).

Additional color charge stool, standard upholstery	---
Additional color charge stool, Ferrari Stamskin upholstery	---
Additional color charge chair, standard upholstery	---
Additional color charge chair, Ferrari Stamskin upholstery	---

Stools & Chairs



Anatomical saddle-seat stool
Large
59-80 cm height adjustment
Art. 42512



Anatomical saddle-seat stool
Large "Air"
59-80 cm height adjustment
integrated air chambers for pressure relief
Art. 42412



Anatomical saddle-seat stool
Large "For Men"
59-80 cm height adjustment
Cut-out in the front seat area
Art. 42411

Chair/Stool "Anatomical saddle-seat"

Our specialists when it comes to ergonomics are the anatomical saddle-seat stools and chairs. Thanks to their specially curved seat design in the Large and Small versions, the saddle-shaped seats ensure optimal pressure distribution in the buttock-area while relieving the strain on the thighs. The "For Men" model, with its recess in the front part of the seat, also caters to the special ergonomic needs of men.

The "floating" version also offers a seat that swings in all directions to maintain the mobility of the pelvis and promote the flexibility of the discs.

All models have the obligatory height adjustment and the five-caster safety base. The chair model is also equipped with an adjustable backrest and a tilting seat.

Properties:

- Anatomically-shaped saddle-seat
- Pneumatic height adjustment
- Rotating saddle-seat
- Comfortable upholstery
- Chair version with inclinable seat to relieve pressure on the thighs
- "Air" chair version with air chambers to relieve pressure
- Washable and durable cover
- Synthetic leather cover in white
- 5-caster safety base
- Rubber castors with Roll-Stop function
- Optional with floating equipment: swinging, adaptable to the movement of the seat, in two types of firmness (soft and medium)
- Base in three colors: Black (standard), titanium, or chrome
- Four-caster base versions (see page 333)



Anatomical saddle-seat stool
Small "Floating"

47-63 cm height adjustment
with movable seat with 2 degrees of firmness

Art. 42401W	soft	---
Art. 42401M	medium	---
Art. 42401OF	without floating	---



Anatomical "Small" saddle-seat
chair

Height adjustment 47-63 cm (short pneumatic spring), 56-80 cm (long pneumatic spring)

Art. 42501	with short pneumatic spring	---
Art. 42498	with long pneumatic spring	---

Stools & Chairs

Chair/Stool "Saddle-seat"

Our saddle-seat chairs or stools have a specially shaped seat similar to a bicycle. The advantage here: The recesses on the seat minimize the unpleasant pressure of the seat on the thighs.

The durable synthetic leather upholstery is available in different colors (see color chart in the cover)

All models have the obligatory height adjustment and the five-castor safety base. The chair model is also equipped with an adjustable backrest as well as a tilting seat.

Features:

- 50-62 cm height adjustment
- Saddle-shaped, flat seat
- Pneumatic height adjustment
- Rotating saddle-seat
- Chair version optionally with inclinable seat to relieve pressure on the thighs
- Comfortable upholstery
- Washable and durable cover
- Synthetic leather cover in white, additional colors optional
- 5-castor safety base
- Rubber castors with Roll-Stop function
- Base in three colors: Black (standard), titanium, or chrome
- Four-castor base versions (see page 333)



Saddle-seat stool

Art. 42502



Saddle-seat chair

Art. 42506

Art. 42509 with inclinable seat

"Round" chair/stool

Our round stools and chairs feature comfortable and robust upholstery.

The durable synthetic leather cover is available in different colors (see color chart in the cover)

All models have the obligatory height adjustment and the five-caster safety base. The chair model is also equipped with an adjustable backrest as well as a tilting seat.

Properties:

- 50-62 cm height adjustment
- Round, flat seat
- Pneumatic height adjustment
- Rotatable seat
- Chair version optionally with inclinable seat to relieve pressure on the thighs
- Comfortable upholstery
- Washable and durable cover
- Synthetic leather cover in white, additional colors optional
- 5-caster safety base
- Rubber castors with Roll-Stop function
- Base in three colors: Black (standard), titanium, or chrome
- Four-caster base versions (see page 333)



Stool with round seat

Art. 42503



Chair with round seat

Art. 42505

Art. 42508 with inclinable seat

Stools & Chairs



"PU" stools

Art. 42420



"PU" chair with curved rest

Art. 42430



"PU" stools

The stool with the exceptional design and integrated backrest is available in both polyurethane and synthetic leather upholstery. Its specially shaped seat supports upright spinal posture during work.

The stool is height-adjustable via a lever and has a 5-caster safety base.

Features:

- Pneumatic height adjustment of 46-59.5 cm
- Ergonomically-shaped seat and integrated PU backrest
- Comfortable upholstery
- Washable and durable surface in grey
- Also available with synthetic leather cover
- 5-caster safety base
- Rubber castors with Roll-Stop function
- Base in three colors: Black (standard), titanium, or chrome
- Four-caster base versions (see page 333)

"PU" chair

In this functional chair, both the seat and the backrests are made of robust and easy-to-clean polyurethane. The backrest can be moved to the left and right while seated and can therefore also be used as an armrest.

The chair is also height-adjustable via a lever and has a 5-caster safety base.

Properties:

- Pneumatic height adjustment of 50-63 cm
- Round seat and independently rotatable backrest made of PU
- Comfortable upholstery
- Washable and durable surface in grey
- 5-caster safety base
- Rubber castors with Roll-Stop function
- Comes standard with a black base, optional in titanium or chrome
- Four-caster base versions (see page 333)

"Oval" chair

With its wider seat and curved, height-adjustable backrest, the chair with oval seat provides comfort. In addition, it can be equipped with the Air-Floating system, which with its air chambers allows the adjustment of the seat upholstery to your personal needs. The optional seat tilt adjustment provides relief for the thighs.

Features:

- Pneumatic height adjustment of 50-63 cm
- Rotating oval seat
- Optionally with inclinable seat to relieve pressure on the thighs
- Washable and durable cover
- Synthetic leather cover in white or color
- Optionally with Air-Floating System (AFS) for more comfort and to avoid pressure points
- 5-castor safety base
- Rubber castors with Roll-Stop function
- Base in three colors: Black (standard), titanium, or chrome
- Four-castor base versions (see page 333)

"Dental type" chair

With this functional chair, the backrest can also be moved to the left and right while seated and can therefore also be used as an armrest.

The chair is height-adjustable via a lever and has a 5-castor safety base.

Properties:

- Pneumatic height adjustment of 50-62 cm
- Round seat and rotating backrest
- Comfortable upholstery and upholstered backrest
- Optional with floating equipment: swinging, adaptable to the movement of the seat, in two types of firmness
- Durable cover in white or color
- 5-castor safety base
- Rubber castors with Roll-Stop function
- Standard with black base, optional in titanium or chrome
- Four-castor base versions (see page 333)



"Oval" chair

Art. 42515	---
Art. 42516 with inclinable seat	---
Art. 42515AF with Air-Floating-System	---
Art. 42516AF inclinable + AFS	---



"Dental type" chair

Art. 72100	---
Art. 72101 with Floating-Option	---

Stools & Chairs

"Square" chair

A modern design with clean lines and extremely comfortable – this is the "Square" Chair. Whether as a working chair with and without a backrest or as a makeup chair, the Square offers an exclusive solution for most requirements. The robust, easy-to-clean synthetic leather upholstery is available as standard in white or optionally in other colors from our current color charts (see cover). In addition to the obligatory height adjustment, the makeup chair has a footrest ring for optimum seating comfort.

Features:

- In three chair versions: Working chair with and without armrests or makeup chair
- Pneumatic height adjustment from 47-63 cm (working chair), approx. 57 - 83 cm (makeup chair)
- Rotating, angular chair
- Comfortable upholstery and backrest
- Armrests
- Washable and durable cover
- Synthetic leather cover in white or color
- Optionally with castors or fixed base
- Rubber castors with Roll-Stop function



"Square" chair without armrest

Art. 42802



"Square" chair with armrest

Art. 42800



"Square" makeup chair

Art. 42801

"Small" chair

With its angular shape, the "Small" is one of the classic working chairs. It features enormous versatility: Whether with or without armrests, with or without castors, or as a makeup chair, the "Small" offers the right seating to meet every need. The standard white seat and backrest can also be chosen in one color from our color chart (see cover). In addition to the obligatory height adjustment, the makeup chair has a foot rest ring for optimum seating comfort.

Features:

- "Small" without armrests height adjustment: 47-60 cm, "Small" with armrests: 40-53 cm, "Small" makeup chair: 57-83 cm
- Rotating, angular chair
- Optional: inclinable seat to relieve pressure on the thighs
- Comfortable upholstery and backrest
- Washable and durable cover
- Synthetic leather cover in white or color
- Choose from castors or fixed base
- Rubber castors with Roll-Stop function
- Comes standard with a black base, optional in titanium or chrome (depends upon the model)
- Four-castor base versions (see page 333)



"Small" chair without armrest

Art. 42504

Art. 42507 with inclinable seat

"Small" chair with armrest

Art. 42555

"Small" makeup chair

Art. 42076

Stools & Chairs



"Rondo" Chair

Art. 42600



"Rondo" Chair

This designer piece is an absolute "must" for an exclusive studio. Completely covered with synthetic leather, the "Rondo" can be equipped with different trending colors from our collections.

The chrome base with its height-adjustable pneumatic spring completes its sophisticated appearance.

Features:

- Pneumatic height adjustment of 47-63 cm
- Rotating, round seat
- Comfortable upholstery and backrest
- Washable and durable cover
- Synthetic leather cover in white or color
- Chrome base
- 5-cross safety base with castors
- Rubber castors with Roll-Stop function

"MLX" Chair

Top design and sophisticated functionality - the "MLX" combines both. In addition to the exceptionally designed seat made from robust synthetic leather and the wood decor applications on the back, the designer chair captivates with its integrated storage compartment.

The height adjustment of 50-62 cm and the fully adjustable backrest make this chair an exclusive piece of furniture that perfectly matches the design of our spa table models.

Features:

- Exclusively designed seat with integrated storage compartment
- Pneumatic height adjustment of 50-62 cm
- Rotatable seat
- Rest with height and inclination adjustment
- attractive wood decor applications in various designs
- 5-caster safety base
- Rubber castors with Roll-Stop function
- Durable cover
- Synthetic leather cover in white or color



"MLX" Chair

Art. 42999



Bürgenstock Resort Lake Lucerne Switzerland





© Copyright 2019 Gharieni Group GmbH. All rights reserved. Please note that all images and text in this catalog are subject to industrial property rights of the Gharieni Group GmbH or their owners and that no license is granted. The Gharieni logo is the registered trademark of Gharieni Group GmbH. All other product or service names mentioned in this catalog are trademarks of their respective companies. Reproduction – even in excerpts – only with the express permission of Gharieni Group GmbH.

Picture and color illustrations may differ. Printing errors, mistakes, product and price changes reserved.

Prices in Euro plus VAT and shipping, without equipment and decoration!

Image sources:

Maygutyak - Fotolia // sghiaseddin - stock.adobe.com // Martin Schenzer // contrastwerkstatt // swillklitch // Fernando Batista // Destina - stock.adobe.com

Gharieni Color Charts

PU upholstery colors



Synthetic leather upholstery colors



Serge Ferrari Color Charts



"Stamskin Top" synthetic leather



"Stamskin One" synthetic leather



In order to withstand even the most demanding environments (outdoor, medical, yachting, etc.), the innovative new product Stamskin One impresses with unique technical features and an incomparable finish.

Thanks to Serge Ferrari's elastomer technology, Stamskin One is particularly easy to clean and disinfect. The breathable surface is resistant to oils (massage oils, sunscreen, etc.), body fluids, and substances containing alcohol (detergents).

19
20

Moers, Germany | Sales + Showroom // Gharieni Group GmbH • Gutenbergstr. 40 • D-47443 Moers

Moers, Germany | Distribution + Service // Gharieni Group GmbH • Am Schürmannshütt 24 • D-47441 Moers

Tel: +49 - (0) 28 41 - 88 300 - 0 • Fax: +49 - (0) 28 41 - 88 300 - 333 • www.gharieni.com • info@gharieni.com

Ettlingen | Germany // Gharieni Süd GmbH • Siemensstr. 11 • D-76275 Ettlingen

Tel: +49-(0)7243-3322-363 • Fax: +49-(0)7243-3322-391 • ettlingen@gharieni.com

Nederweert | BeNeLux // Gharieni Nederland BV • Hulsenweg 14 • NL-6031SP Nederweert

Tel: +31 (0) 495 - 63 30 36 • Fax: +31 (0) 495 - 62 66 63 • www.gharieni.nl • info@gharieni.nl

Belfort | France // Gharieni France SARL • 5 Rue Jacqueline Auriol • F-90000 Belfort

Tel: +33 (0) 3 39 03 39 47 • Fax: +33 (0) 3 39 03 39 48 • www.gharieni.fr • info@gharieni.fr

Dubai | UAE // Gharieni Middle East FZ-LLC • Dubai Design District D3 • Building 1 Office B208 • Dubai

Tel: +971 (0) 4 2766734 • www.gharieni.ae • info@gharieni.ae

Aventura | USA // Gharieni USA Inc. • JW Marriott Miami Turnberry Resort & Spa • 19999 West Country Club Drive • Aventura Florida 33180

Tel: +1 (855) 378 4772 • www.gharieni.com • info@gharieni.com